

DC-DC LED Constant Current Regulator



24W 1000mA High Efficiency Step Down LED Driver

Power Your Idea

Features

- RoHS-compliant 16 Pin DIL Package
- Constant Current Output ($\pm 7\%$ Output Current Accuracy)
- LED Driver Current up to 1000mA.
- Power LED Driver.
- Wide Input Voltage Range: 7V to 30V (40V for 0.5sec.)
- Output Power to 24W.
- Driver LED Strings of up to 28V (2V to 28V).
- High Efficiency (up to 95%).
- PWM / Digital Dimming and Analog Voltage Dimming.
- Open and Short LED Protection.
- $-40^{\circ}\text{C} \sim 85^{\circ}\text{C}$ Operation Temperature Range.



Application

- 12V and 24V Lighting Systems
- Household/Commercial Lighting
- Suitable for High illumination LED
- Power Limited (battery) Lighting System

GP-LDA028-0M is a high efficiency step-down converter optimized to drive high current LEDs. The control algorithm allows highly efficient and accurate LED current regulation. The device operates from an input 7Vdc to 30Vdc and provides an externally adjustable output current of up to 1000mA and output power up to 24 watts. Compact size of DIL16 allows designer to integrate this driver together with LED module. UL-94V0 grade molded case with high grade filling material provide excellent fire proof characteristics.

(Typical at $T_a = +25^{\circ}\text{C}$, nominal input voltage, rated output current unless otherwise specified.)

Electrical Specifications:	
Input Voltage (Vdc)	7V ~ 30V (40V for 0.5 sec)
Input Filter Capacitor	Capacitor
Output Voltage Range ($V_{in} = 30\text{V}$)	2V to 28V
Output Current Range ($V_{in} - V_{out} > 2\text{V}$ to 3V)	1000mA
Output Current Accuracy ($I_{out} = 1000\text{mA}$)	$\pm 7\%$
Output Power	24W Max.
Ripple and Noise, (20 MHz bandwidth)	300mVp-p Max.
Maximum Efficiency at Full Load	95%
Capacitive Load	47uF
Operating Frequency	50kHz ~ 300kHz
Short Circuit Protection	Regulated at Rated Output Current
Temperature Coefficient ($T_a = -40^{\circ}\text{C}$ to $+85^{\circ}\text{C}$)	$\pm 0.08\%/^{\circ}\text{C}$ Max.
Thermal Impedance (Nature Convection)	$+50^{\circ}\text{C}/\text{W}$
Safety Standard : (designed to meet)	IEC / EN 60950-1

Environmental Specifications	
Operating Temperature Range, T_a	-40°C to $+71^{\circ}\text{C}$
Storage Temperature Range	-40°C to $+125^{\circ}\text{C}$
Humidity	95% rel H
Maximum Case Temperature	$+100^{\circ}\text{C}$
Cooling	Nature Convection
Reliability Calculated MTBF (MIL-HDBK-217 F)	> 4.7 Mhrs
Soldering Temperature (1.5mm from case 10sec.)	$+260^{\circ}\text{C}$

Physical Specifications	
Case Material	Non-Conductive Black Plastic (UL94V-0 rated)
Potting Material	Silicon (UL94-V0 rated)
Pin Material	0.5mm Brass Solder-coated
Weight	6.2g
Dimensions	0.92"x0.55"x0.40"

PWM Dimming and ON/OFF Control (Leave Open if Not Used):	
Remote ON/OFF	
DC/DC ON.....	Open or $0.3\text{V} < V_{ADJ} < 1.25\text{V}$
DC/DC OFF (Shutdown)	$V_{ADJ} < 0.15\text{V}$
Remote Pin Drive Current ($V_{ADJ} = 1.25\text{V}$)	$< 1\text{mA}$
Quiescent Input Current in Shutdown Mode ($V_{in} = 30\text{V}$)	$25\mu\text{A}$ Max.
PWM Dimming	
Recommended Maximum Operation Frequency	1KHz
Minimum Switch 'ON' Time	200ns
Minimum Switch 'OFF' Time	200ns

Analog Dimming Control (Leave Open if Not Used):	
VADJ Input Voltage Range	0.3V to 1.25V
Adjust Output Current	25% to 100%
Control Voltage Range Limits	
On	$0.2\text{V} \sim 0.3\text{V}$
Off	$0.15\text{V} \sim 0.25\text{V}$
Analog Pin Drive Current ($V_{ADJ} = 1.25\text{V}$)	$< 1\text{mA}$

EMC Specifications	
EMI Radiated & Conducted Emissions EN 55015 (CISPR22)	
EMS Immunity EN 61547	
IEC 61000-4-2	Perf. Criteria A
IEC 61000-4-3	Perf. Criteria A
IEC 61000-4-4	Perf. Criteria A
IEC 61000-4-6	Perf. Criteria A
IEC 61000-4-8	Perf. Criteria A

NOTE

1. Reversed power source damages the circuit, No connection is allowed between input ground and output.
2. DO NOT operate the driver over 24W output.
3. Leave pin VADJ open if not in use, ground pin to shut down the converter. Connecting Vadj to Vin damages the circuit.
4. Maximum output open voltage is equal to input voltage.
5. Input filter components (C1, L, C2) are used to help meet conducted emissions requirement for the module.
6. For the compliance with EN61000-4-5, a TVS is thus recommended to be installed in front of the input filter, the reference model: 3.0SMCJ24A or SMCJ24A (TVS Max Clamping Voltage @ Max Peak Pulse Current VC (V) $\leq 40\text{V}$)

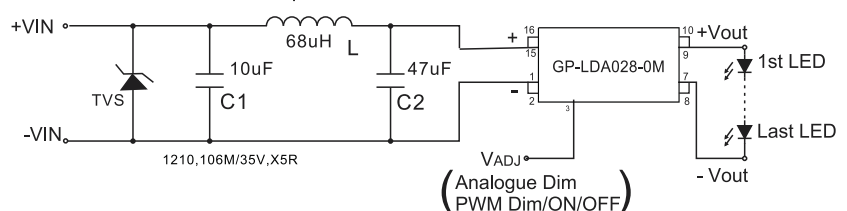

Typical Operating Conditions

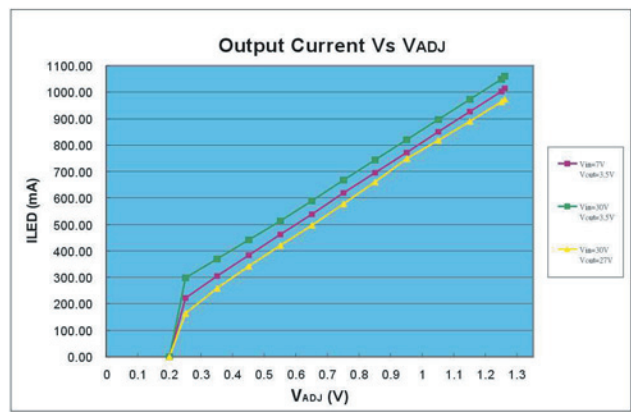
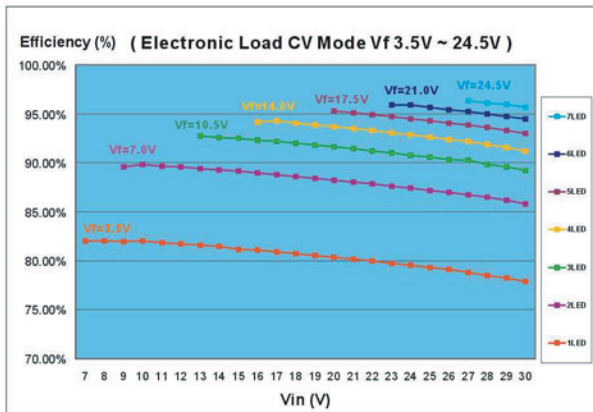
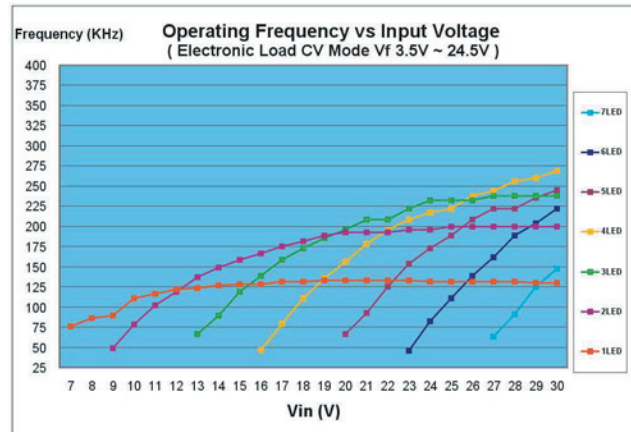
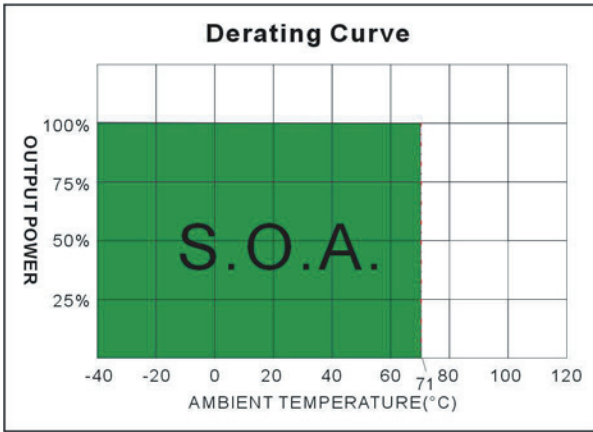

MECHANICAL DIMENSION

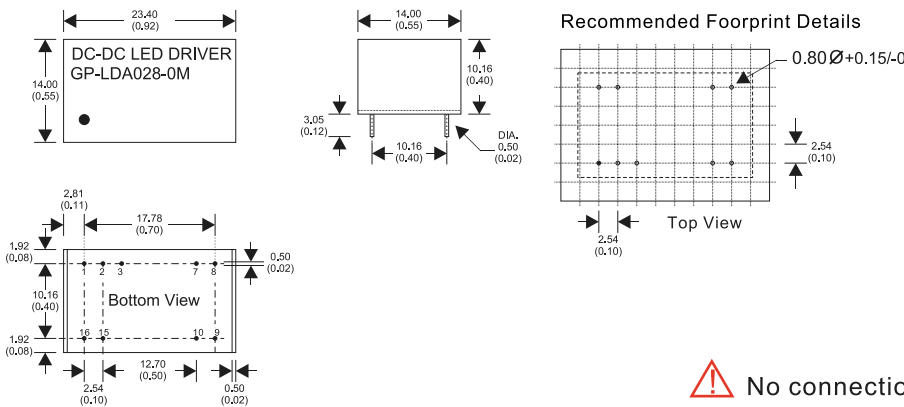

16 Pin DIL Package

- Notes : All dimensions are typical in millimeters (inches).
1. Pin diameter: 0.5±0.05 (0.02±0.002)
 2. Pin pitch tolerance: ±0.35 (±0.014)
 3. Case Tolerance: ±0.5 (±0.02)

Pin #	CONNECTIONS	
1,2	- V Input	- DC Supply
3	VADJ	PWM/ON/OFF or not used
7,8	- V Output	LED Cathode Connection
9,10	+V Output	LED Anode Connection
15,16	+V Input	+DC Supply

No connection is allowed between input and output

Main Terminal Disturbance Voltage Measurement

POLARITY: Line

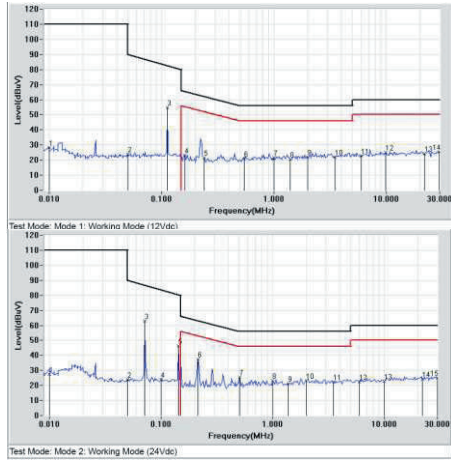

POLARITY: Neutral

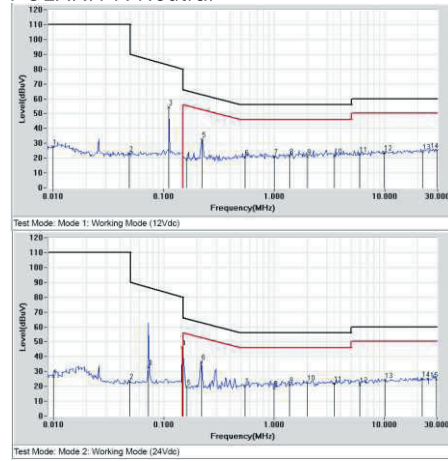

Radiated disturbance (9 kHz to 30 MHz) Measurement

POLARITY: Loop1

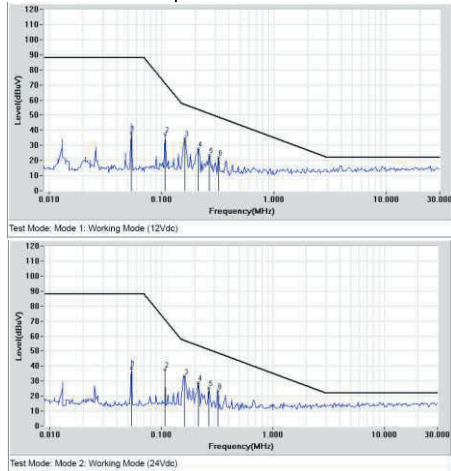

POLARITY: Loop2

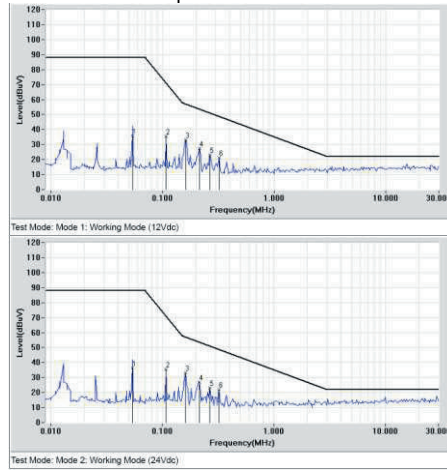

POLARITY: Loop3

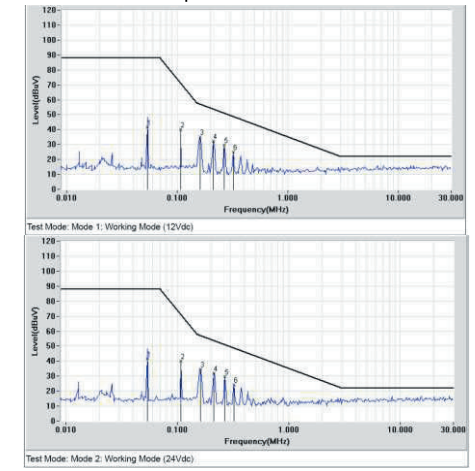

Radiated disturbance (30 MHz to 300 MHz) Measurement

POLARITY: Horizontal

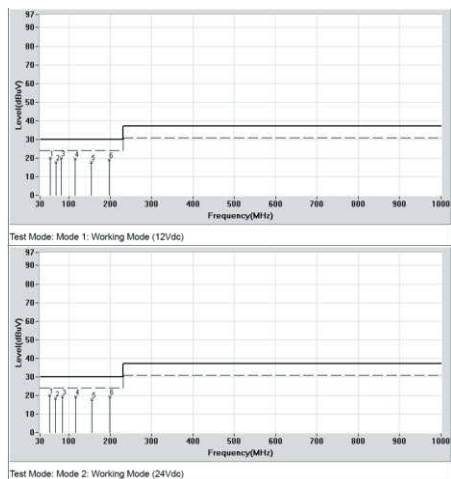

POLARITY: Vertical

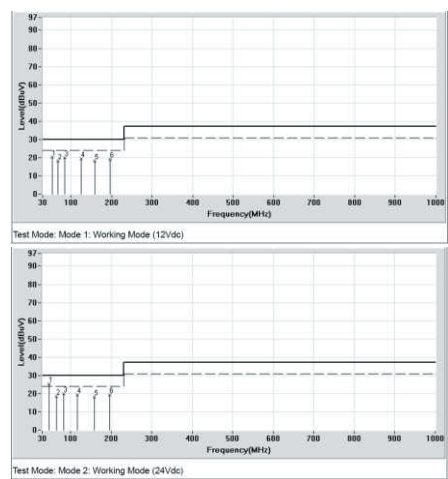

Typical application

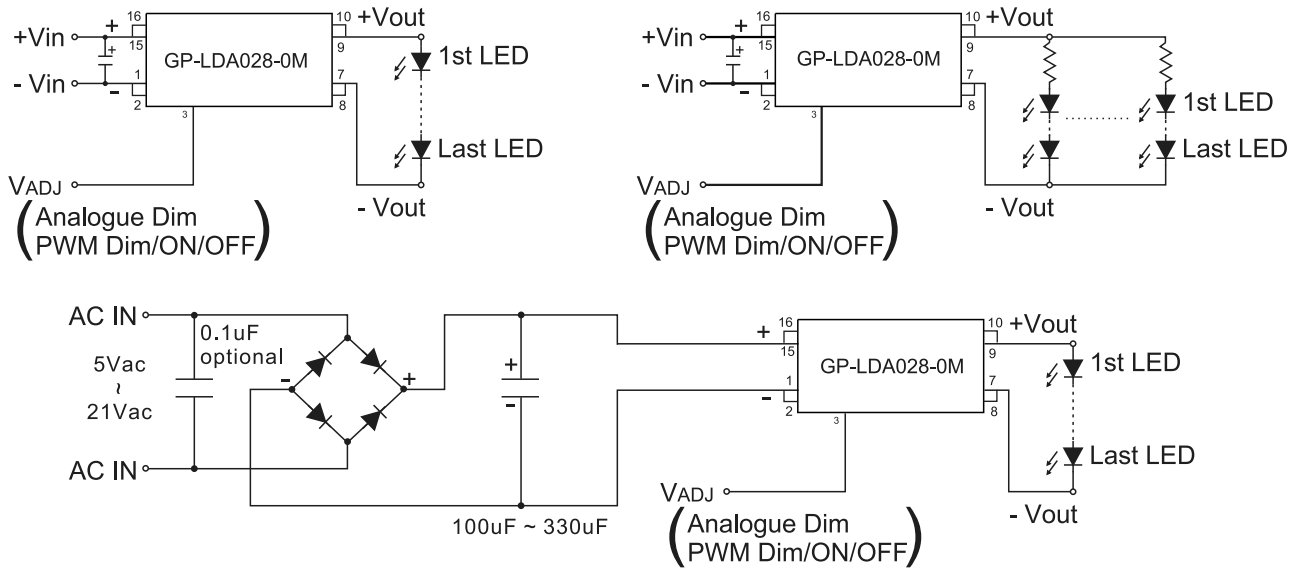

Output Current Adjustment By External DC Control Voltage

The nominal output current is then given by:

$$I_{out} \approx \frac{0.08 \times V_{ADJ}}{0.095}$$

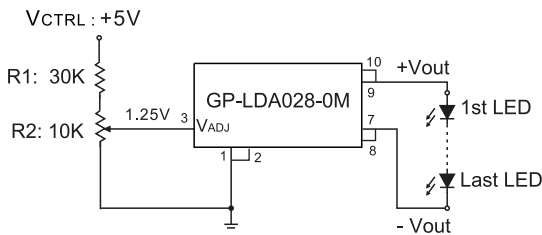
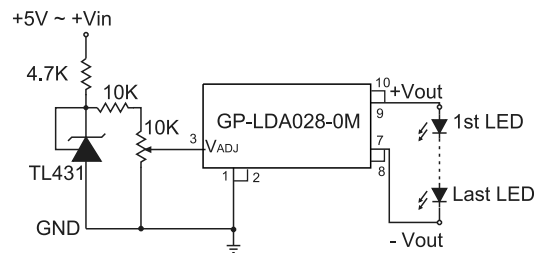
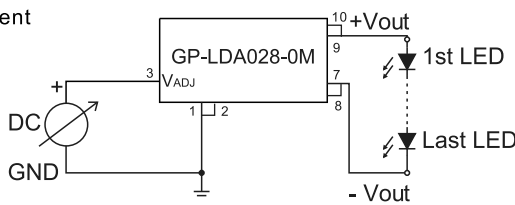

$$V_{ADJ} = \frac{R_2}{R_1 + R_2} \times V_{CTRL}$$

Resistor dimming

By connecting a variable resistor between ADJ and GND, simple dimming can be achieved. Capacitor CADJ is optional for better AC mains interference and HF noise rejection. Recommend value of CADJ is 0.22uF.

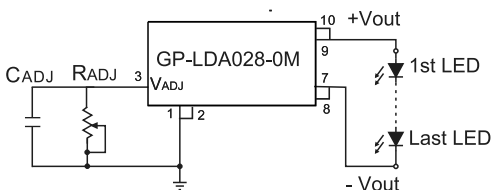

The current output can be determined using the equation:

$$I_{out} = \frac{(0.08 / 0.095) \times R_{ADJ}}{(R_{ADJ} + 200K)}$$

Typical application

Output Current Adjustment By PWM Control

Directly driving ADJ input

A Pulse Width Modulated (PWM) signal with duty cycle DPWM can be applied to the ADJ pin, as shown below

$$I_{out} \approx \frac{0.1DPWM}{0.095} \quad [for \ 0 < DPWM < 1]$$

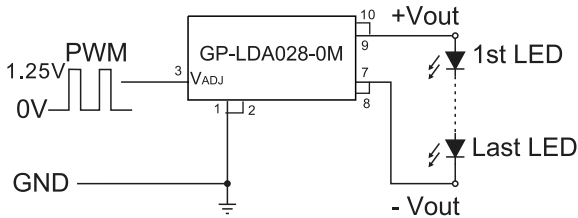

Driving the ADJ input via open collector transistor
The diode and resistor suppress possible high amplitude negative spikes on the ADJ input resulting from the drain-source capacitance of the transistor. Negative spikes at the input to the device should be avoided as they may cause errors in output current, or erratic device operation.

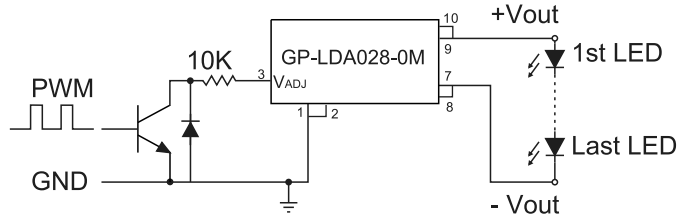

Driving the ADJ input from a microcontroller

Another possibility is to drive the device from the open drain output of a microcontroller. The diagram below shows one method of doing this:

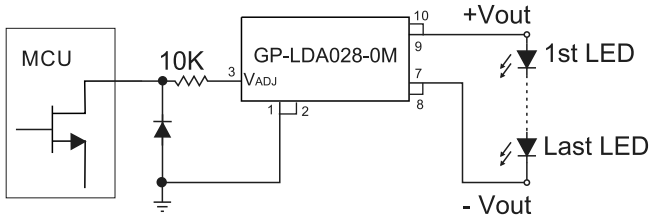

The diode and resistor suppress possible high amplitude negative spikes on the ADJ input resulting from the drain-source capacitance of the FET. Negative spikes at the input to the device should be avoided as they may cause errors in output current, or erratic device operation.

Output Current Adjustment By PWM Control (Dimming)

To avoid visible flicker the PWM signal must be greater than 100Hz.

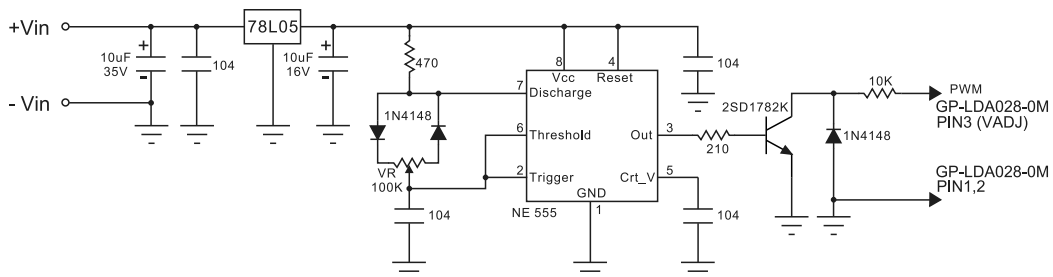

Output Current Adjustment By PWM Control (Flash)

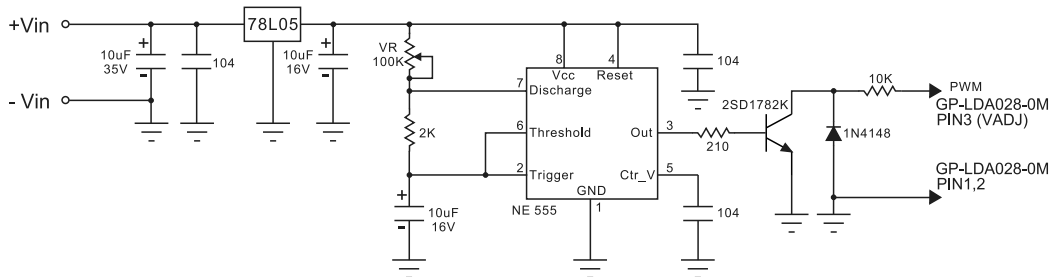

Typical application

Output Current Adjustment By External DC Control Voltage

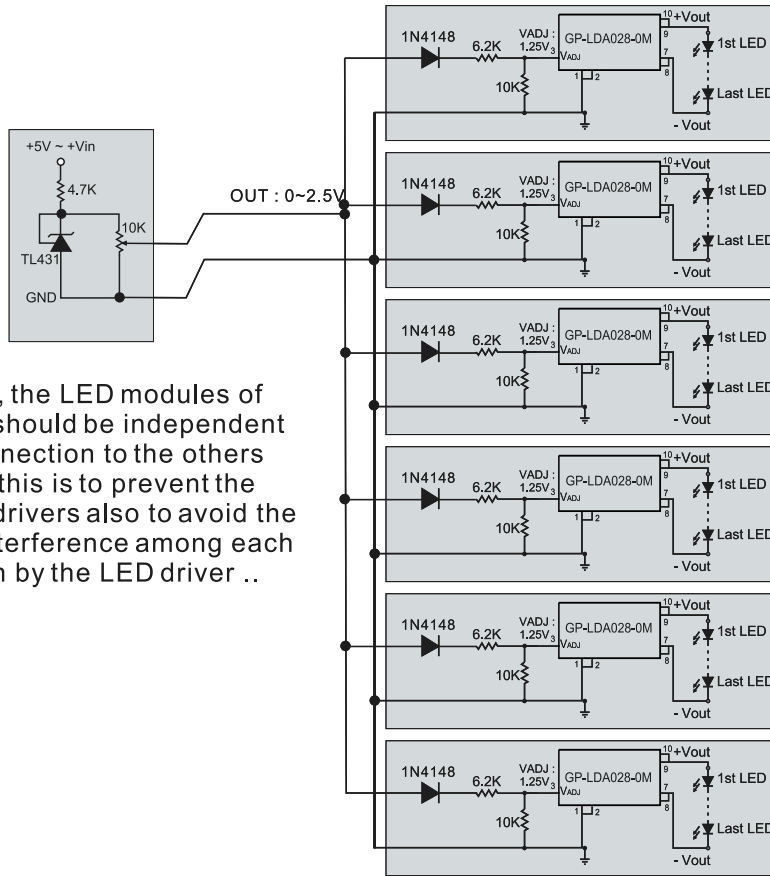

In this application, the LED modules of each LED drivers should be independent from electrical connection to the others and input power - this is to prevent the damaging to LED drivers also to avoid the un-necessary interference among each LED module driven by the LED driver ..

Thermal feedback circuit

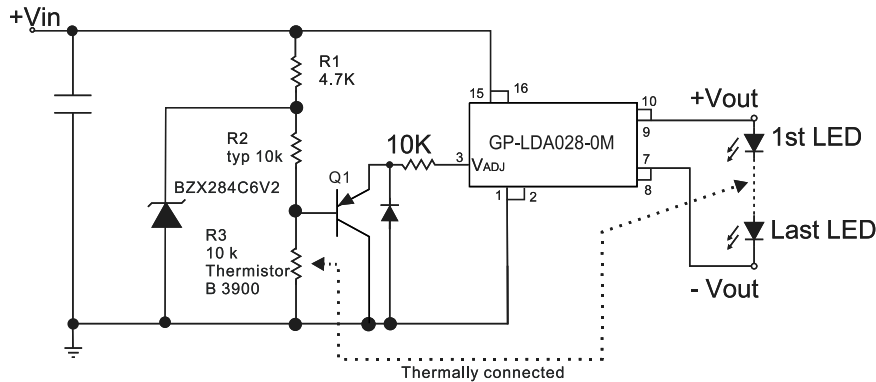

The selection of components for the thermal feedback circuit is not only dependent on the choice of R2 and R3, but also on the amount of heat sink area required to extract heat from the LEDs. To maximize the light output at high ambient or operating temperature conditions, the LEDs must have a sufficient thermal extraction path, otherwise the thermal control circuit will effect current drive reduction in non-optimal conditions. The thermal control threshold point is set by adjusting R2. For this design, three values (33k, 22k and 10k) were evaluated. These values were chosen to give break points at approximately 25°C, 40°C and 60°C.

Note that the light output will not continually dim to zero - the thermal control is applying DC control to the ADJ pin and therefore has a dimming ratio from maximum Current of approximately 5:1. Once the reduced DC level goes below the shutdown threshold of around 200mV, the LED drive current will fall to zero and the LEDs will be extinguished. The slope of the current reduction is determined by the beta value of the thermistor. The larger the beta value, the sharper will be the resultant current control response. The slope of the current reduction is also affected by Q1's base emitter voltage (VBE) variation with temperature.