

Model: GP-CVP150P-xxV-T01 Series

■ Features

- Universal AC Input Range 90 ~ 264VAC.
- Constant Voltage mode.
- Active PFC design.
- Protections: OVP / OCP / SCP / OTP.
- High Efficiency up to 91.5 %
- Fully Insulated Plastic Case.
- Meet application for ErP (EU) 2019/2020
- No-load power consumption < 0.5W at 230VAC
- Set up time < 0.5S at 230VAC.
- Suitable for LED strips and Moving Sign applications.
- Withstand 300VAC Surge Input for 5 Seconds.

■ Approvals



■ Size

204 x 53.5 x 30mm (L x W x H)



Note: GP-CVP150P-xxV-T01: xx=12, 24, 36, 48

■ Specifications

Model No.		GP-CVP150P-12V-T01	GP-CVP150P-24V-T01	GP-CVP150P-36V-T01	GP-CVP150P-48V-T01	
Output	DC Voltage	12V	24V	36V	48V	
	Rated Current	0~11.0A	0~6.25A	0~4.2A	0~3.15A	
	Rated Power					132W
	Rated Current	0~10.0A	0~5.0A	0~3.35A	0~2.5A	
	Rated Power					120W
	Ripple & Noise (Max.)	Note.2	200mV	200mV	360mV	480mV
	Efficiency at 230VAC (Typ.)		89%	91%	91%	91.5%
	Voltage Tolerance	Note.3	± 5%	± 5%	± 5%	± 5%
Set up time (Max.)		≤ 0.5S at 230VAC, full load.				
Input	Rated Voltage	100 ~ 240VAC 141~340VDC				
	Voltage Range	90 ~ 264VAC				
	Frequency Range	47 Hz ~ 63 Hz				
	AC Current (Max.)	1.3A at 115VAC / 0.8A at 230VAC				
	Power Factor	>0.98 at 115VAC / >0.95 at 230VAC, full load.				
	Total Harmonic Distortion	THD < 10% at 230VAC, full load				
	Inrush Current (Typ.)	Cold Start 55A (Td=630us measured at 50% Ipeak) at 230VAC				
	Max. Number of PSUs on Circuit Breaker	B type : 2 units (10A) / 3 units (16A) / 5 units (25A), C type : 3 units (10A) / 5 units (16A) / 9 units (25A), D type : 11 units (16A) / 18 units (25A) at 230VAC				
	Leakage Current	<1mA at 240VAC				
	No-load power consumption	< 0.5W at 230VAC (0.3W Typ.)				

Protections	Over Current	High Voltage Area 200-264VAC Note.5	110%~150%	110%~150%	110%~150%	110%~150%
		Low Voltage Area 100-180VAC Note.5	130%~185%	130%~185%	130%~185%	130%~185%
	Type: Hiccup mode (Auto recover after fault condition disappeared).					
	Short Circuit		Type: Hiccup mode (Auto recover after fault condition disappeared).			
	Over Voltage	13.2V~18V		26.4V~36V	39.6V~54V	52.8V~72V
		Type: Hiccup mode (Auto recover after fault condition disappeared).				
Over Temperature	Tcase: 90°C ± 10°C					
	Type: Shut down output , recovers automatically after temperature goes down.					
Environment	Operation Temp.		-30°C ~45°C (Refer to output load derating curve).			
	Operation Humidity		20% ~ 90% RH non-condensing.			
	Storage Temp.		-40 ~ +80°C			
	Storage Humidity		10% ~ 90% RH			
	Vibration		10~500 Hz, 2G 10 min./1 cycle, period for 60 min. each along X, Y, Z axes.			
Safety& EMC	Safety Standards		EN61347-1, EN61347-2-13, independent.			
	Withstand Voltage		I/P-O/P: 3.75KVAC			
	Isolation Resistance		I/P-O/P :100M ohms / 500V DC at 25°C			
	EMI Conduction & Radiation		Compliance to EN55015			
	Harmonic Current		Compliance to EN61000-3-2 Class C(100% load), EN61000-3-3			
	EMS Immunity		Compliance to EN61000-4-2,3,4,5,6,8,11; EN61547, criteria B			
Others	MTBF		100K hours min. MIL-HDBK-217F(25°C)			
	Dimension(L x W x H)		204 x 53.5 x 30mm; 540 g/pcs			
Note	<p>1. All specifications not specially mentioned are measured at 230VAC full load and 25°C ambient temperature.</p> <p>2. Ripple & Noise are measured at 20MHz bandwidth by using a 12" twisted pair-wire terminated with 0.1uf & 47uf parallel capacitor.</p> <p>3. Voltage Tolerance: includes line regulation, load regulation and set-up tolerance.</p> <p>4. The power supply is considered a component which will be installed a final equipment. The final equipment must be re-confirmed that it still meets EMC directives.</p> <p>5. Refer to the Derating Curve of INPUT VOLTAGE below for High Voltage Area and Low Voltage Area.</p>					

■ **Derating Curve**

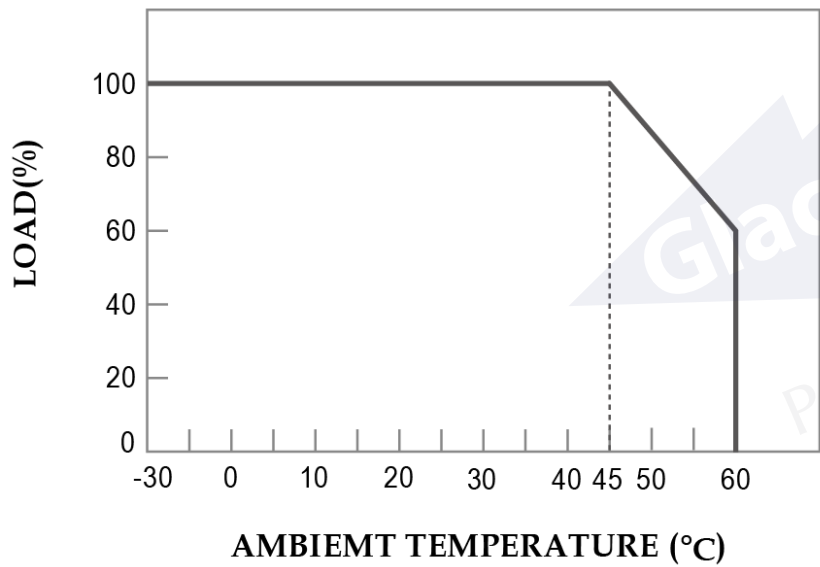

For 12V Model:

For 24V,36V,48V Models:

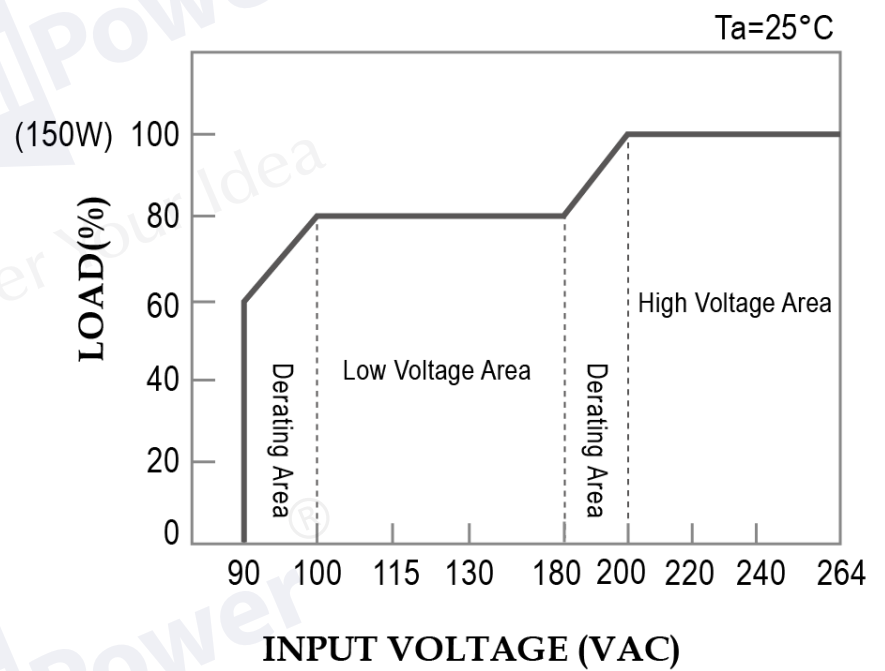
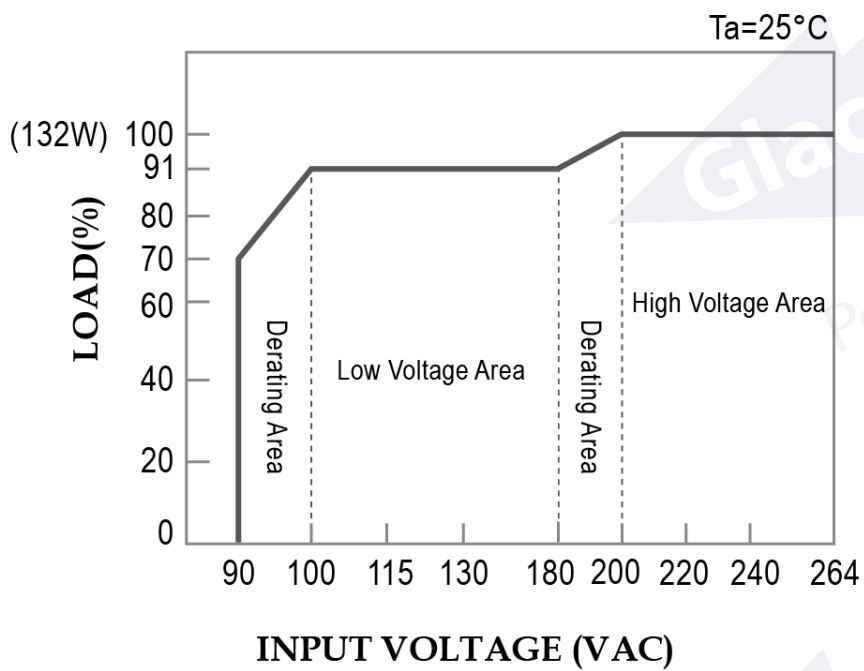

■ **Power Factor (PF) Characteristic** (※Ta at 45°C)

GP-CVP150P-24V-T01 Model

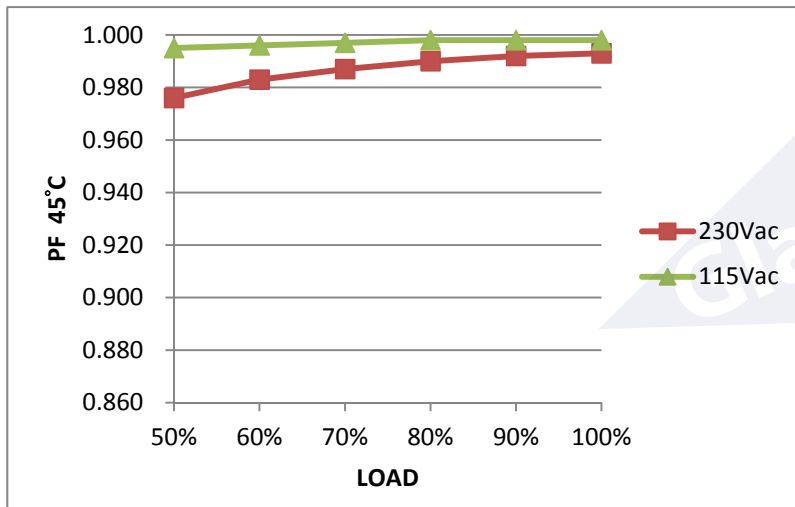

■ **Total Harmonic Distortion (THD)** (※Ta at 45°C)

GP-CVP150P-24V-T01 Model

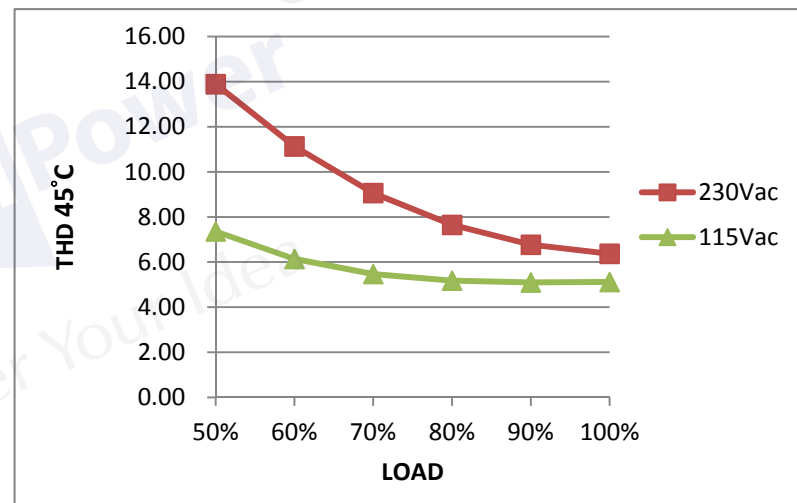

■ **Efficiency vs Load** (※Ta at 45°C)

GP-CVP150P-24V-T01 Model

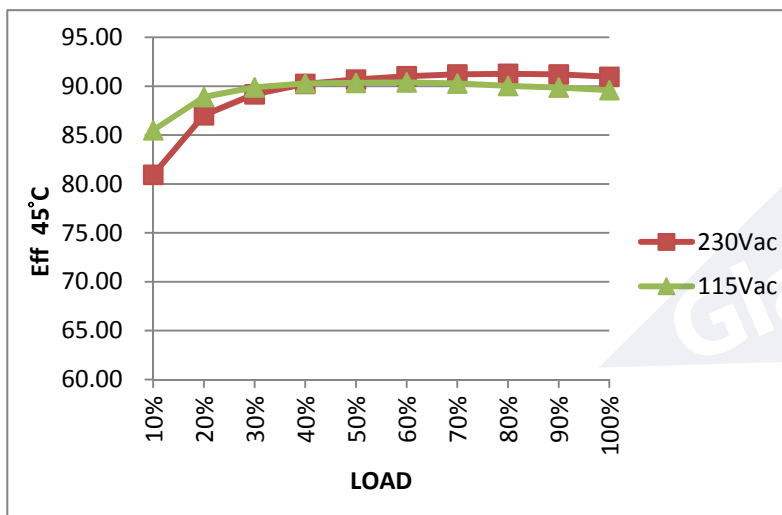

■ **Mechanical Specification**

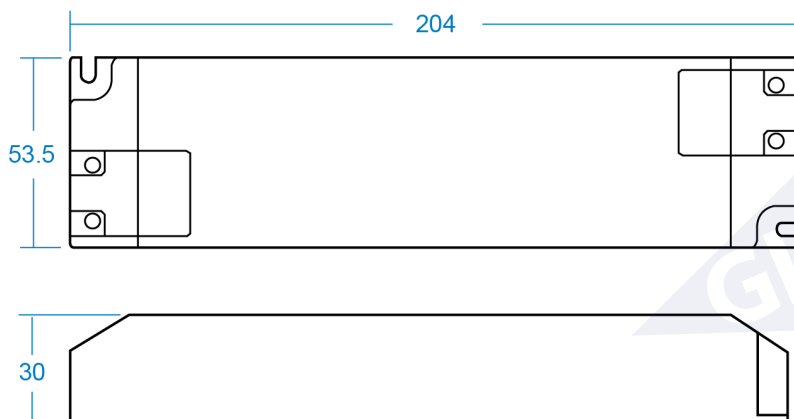

■ **Wire Range for Terminal Block**

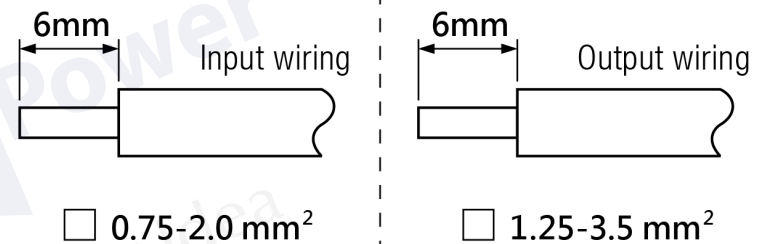

■ Application 1:

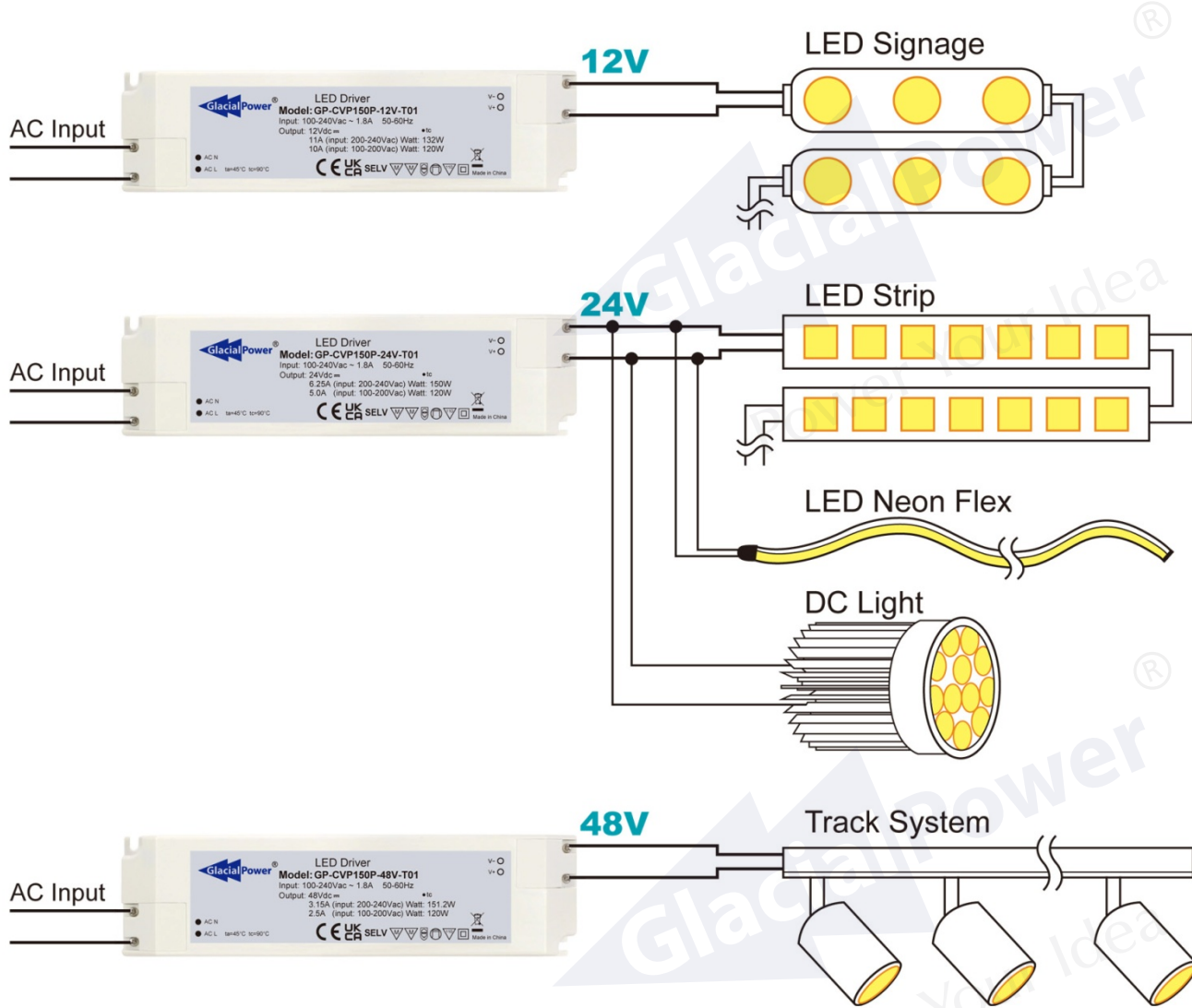

■ Application 2:

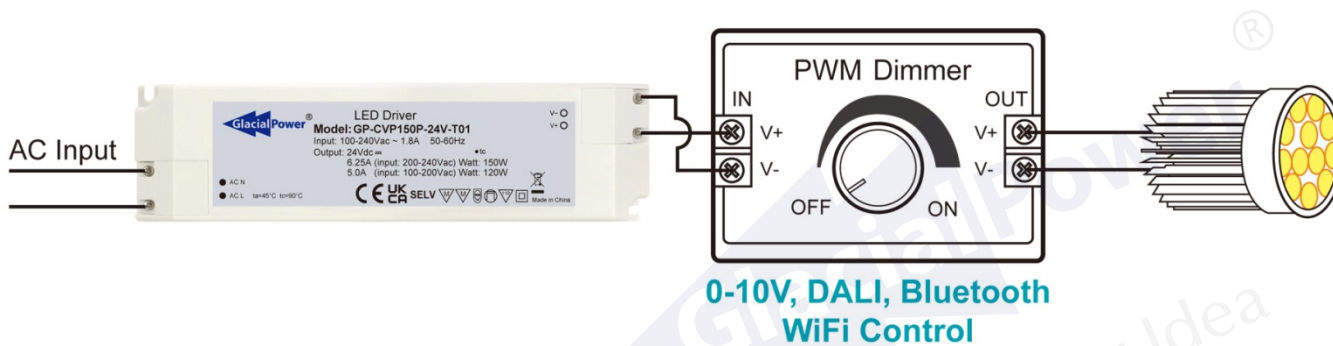

■ **Application 3:**



12V(24V) LED Signage



24V GL MR16, LED Strip & LED Neon Flex



48V Track System

GlacialPower®
Power Your Idea