

## Model: GP-CVP100P-xxV-T02 Series

### ■ Features

- Universal AC Input Range 90 ~ 264VAC.
- Constant Voltage mode.
- Active PFC design.
- Protections: OVP / OCP / SCP / OTP.
- High Efficiency up to 90 %
- Fully Insulated Plastic Case.
- Meet application for ErP (EU) 2019/2020
- No-load power consumption < 0.5W at 230VAC
- Set up time < 0.5S at 230VAC.
- Suitable for LED strips and Moving Sign applications.
- Withstand 300VAC Surge Input for 5 Seconds.

### ■ Approvals



### ■ Size

204 x 53.5 x 30mm (L x W x H)



### ■ Specifications

Model No.		GP-CVP100P-12V-T02	GP-CVP100P-24V-T02	GP-CVP100P-36V-T02	GP-CVP100P-48V-T02
Output	DC Voltage	12V	24V	36V	48V
	Rated Current	0~8.3A	0~4.2A	0~2.8A	0~2.1A
	Rated Power	99.6W	100.8W	100.8W	100.8W
	Ripple & Noise (Max.) Note.2	200mV	200mV	360mV	480mV
	Efficiency at 230VAC (Typ.)	88%	90%	90%	90%
	Voltage Tolerance Note.3	± 5%	± 5%	± 5%	± 5%
	Set up time (Max.)	≤ 0.5S at 230VAC, full load.			
Input	Rated Voltage	100 ~ 240VAC			
	Voltage Range	90 ~ 264VAC			
	Frequency Range	47 Hz ~ 63 Hz			
	AC Current (Max.)	1.1A at 115VAC / 0.52A at 230VAC			
	Power Factor	>0.98 at 115VAC / >0.95 at 230VAC, full load.			
	Total Harmonic Distortion	THD < 12% at 230VAC, full load			
	Inrush Current (Typ.)	Cold Start 55A (Td=450us measured at 50% Ipeak) at 230VAC			
	Max. Number of PSUs on Circuit Breaker	B type : 3 unit (10A) / 5 unit (16A) / 7 unit (25A), C type : 5 unit (10A) / 8 unit (16A) / 13 units (25A), D type : 16 units (16A) / 26 units (25A) at 230VAC			
	Leakage Current	<1mA at 240VAC			
	No-load power consumption	< 0.5W at 230VAC (0.3W Typ.)			

Protections	Over Current	9.13A~12.45A	4.62A~6.3A	3.08A~4.2A	2.31A~3.15A
		Type: Hiccup mode (Auto recover after fault condition disappeared).			
	Short Circuit	Type: Hiccup mode (Auto recover after fault condition disappeared).			
	Over Voltage	13.2V~18V	26.4V~36V	39.6V~54V	52.8V~72V
		Type: Hiccup mode (Auto recover after fault condition disappeared).			
Over Temperature		Tcase: 90°C ± 10°C			
		Type: Shut down output , recovers automatically after temperature goes down.			
Environment	Operation Temp.	-20°C ~50°C (Refer to output load derating curve).			
	Operation Humidity	20% ~ 90% RH non-condensing.			
	Storage Temp.	-40 ~ +80°C			
	Storage Humidity	10% ~ 90% RH			
	Vibration	10~500 Hz, 2G 10 min./1 cycle, period for 60 min. each along X, Y, Z axes.			
Safety& EMC	Safety Standards	EN61347-1, EN61347-2-13, independent.			
	Withstand Voltage	I/P-O/P: 3.75KVAC			
	Isolation Resistance	I/P-O/P :100M ohms / 500V DC at 25°C			
	EMI Conduction & Radiation	Compliance to EN55015			
	Harmonic Current	Compliance to EN61000-3-2 Class C(100% load), EN61000-3-3			
	EMS Immunity	Compliance to EN61000-4-2,3,4,5,6,8,11; EN61547, criteria B			
Others	MTBF	100K hours min. MIL-HDBK-217F(25°C)			
	Dimension(L x W x H)	204 x 53.5 x 30mm; 520 g/pcs			
Note	<p>1. All specifications not specially mentioned are measured at 230VAC full load and 25°C ambient temperature.</p> <p>2. Ripple &amp; Noise are measured at 20MHz bandwidth by using a 12" twisted pair-wire terminated with 0.1uf &amp; 47uf parallel capacitor.</p> <p>3. Voltage Tolerance: includes line regulation, load regulation and set-up tolerance.</p> <p>4. The power supply is considered a component which will be installed a final equipment. The final equipment must be re-confirmed that it still meets EMC directives.</p>				

■ **Derating Curve**

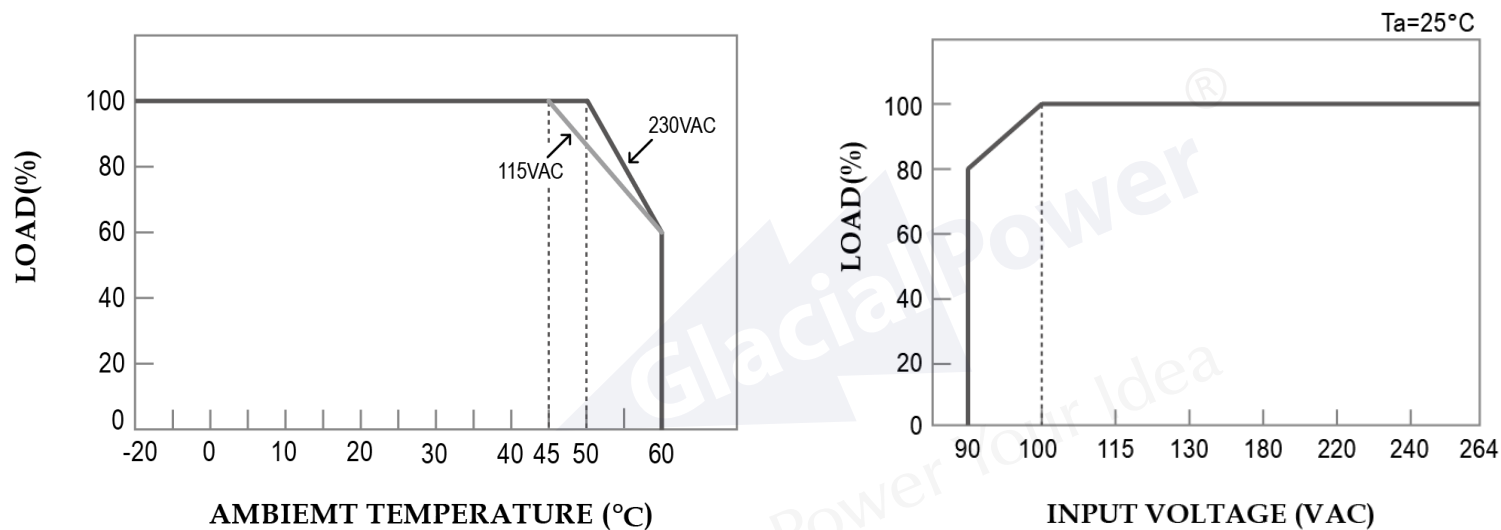

■ **Power Factor (PF) Characteristic** (※Ta at 45°C)

GP-CVP100P-24V-T02 Model

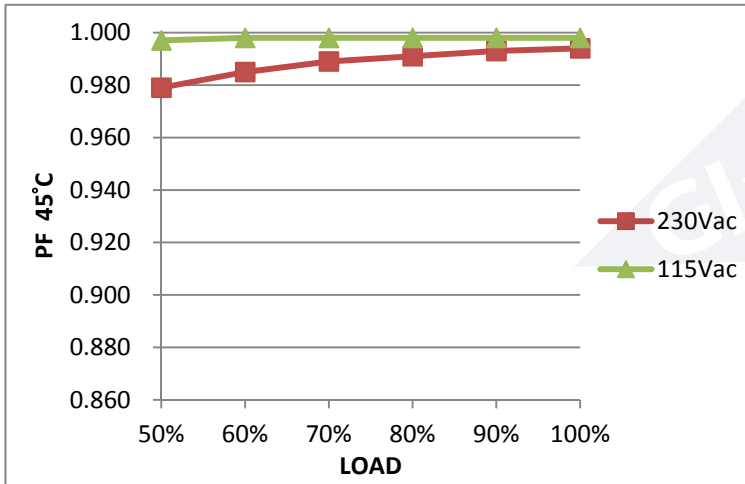

■ **Total Harmonic Distortion (THD)** (※Ta at 45°C)

GP-CVP100P-24V-T02 Model

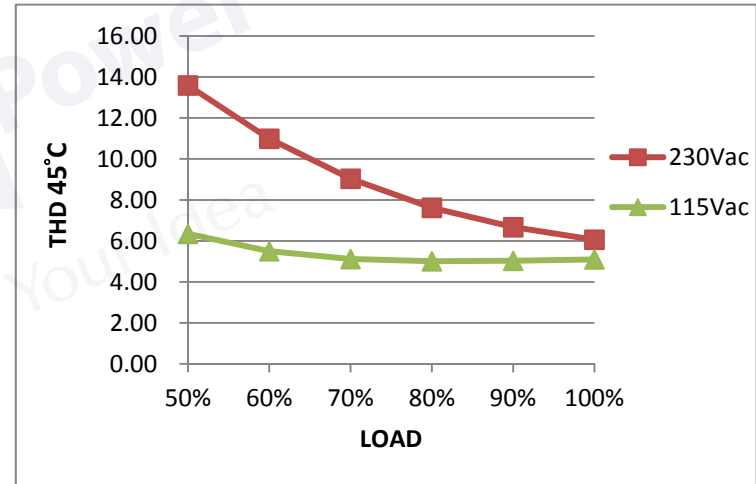

■ **Efficiency vs Load** (※Ta at 45°C)

GP-CVP100P-24V-T02 Model

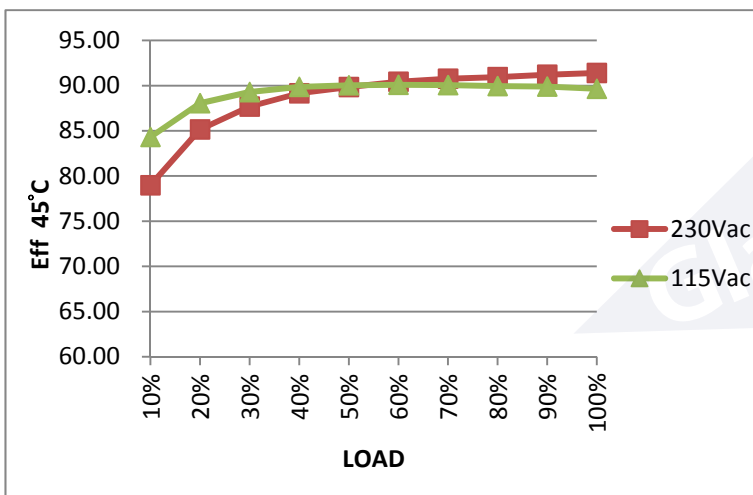

■ **Mechanical Specification**

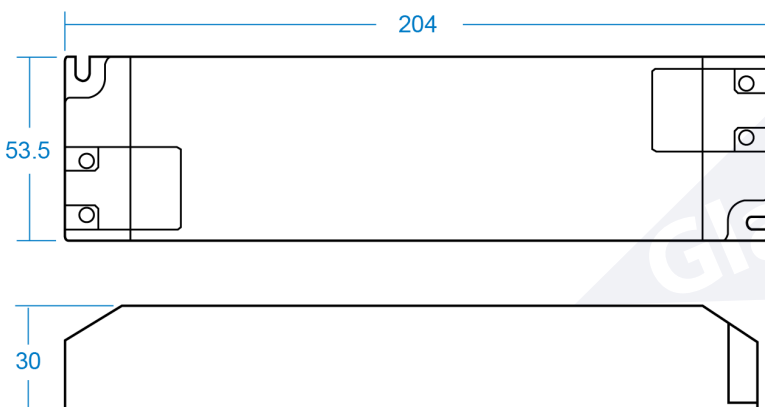

■ **Wire Range for Terminal Block**

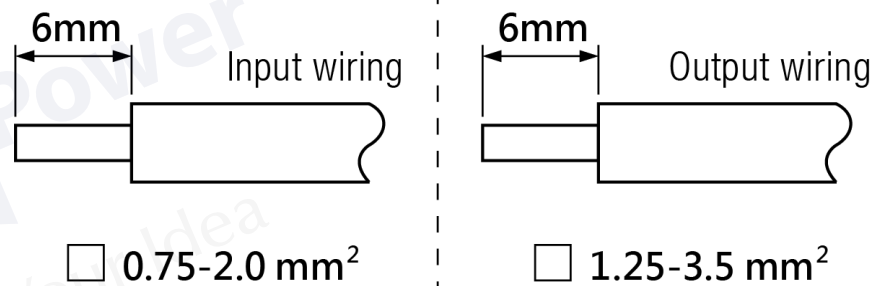

## Application 1:

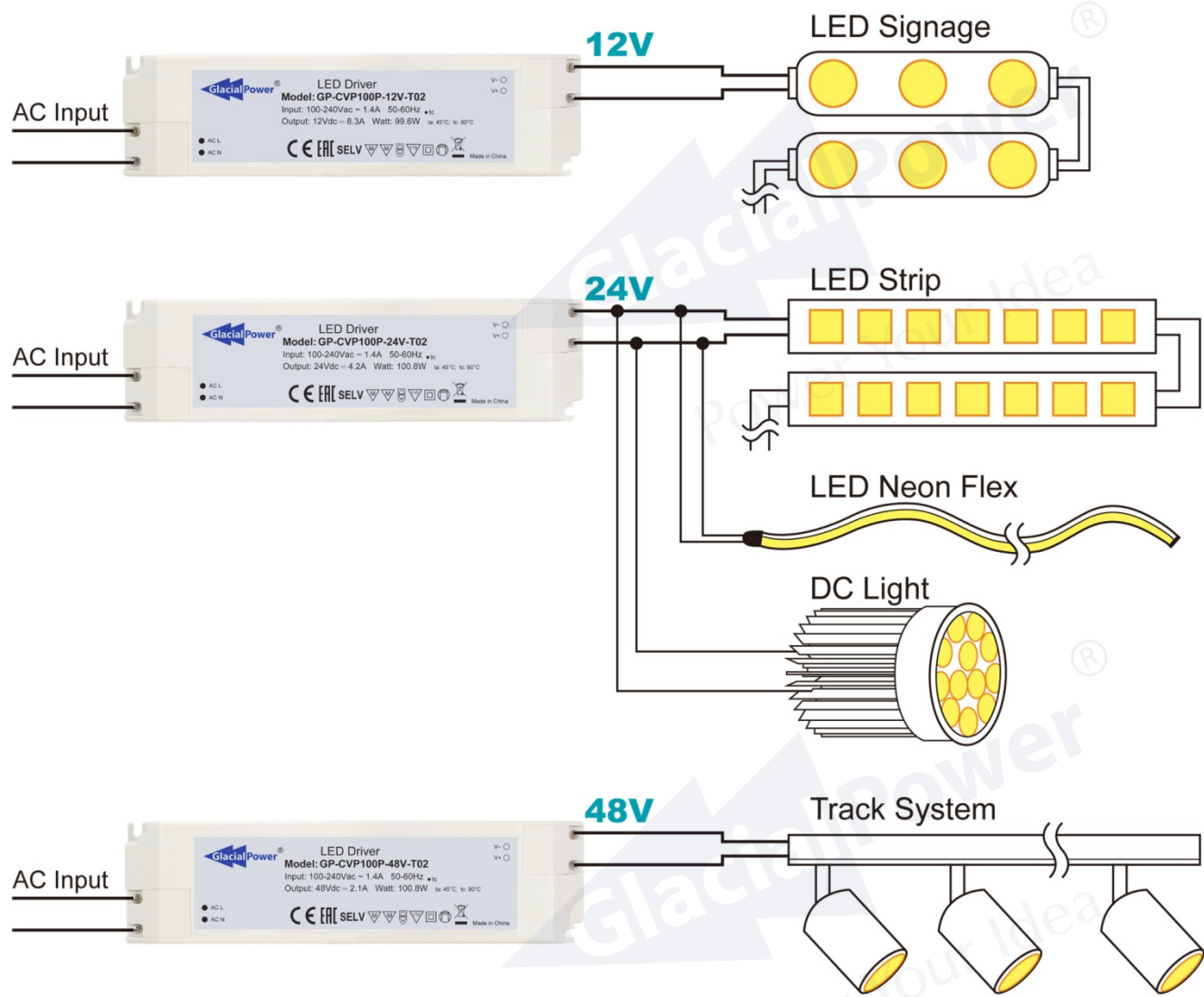

## Application 2:

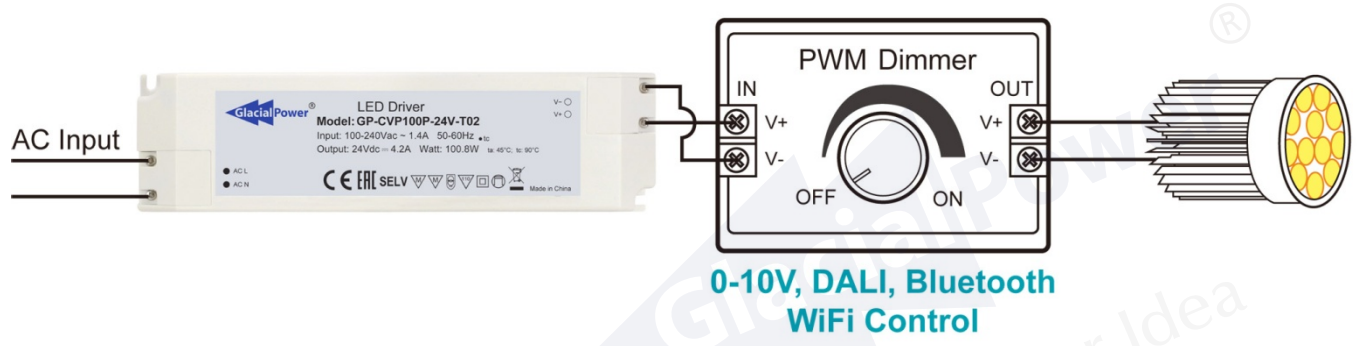

■ **Application 3:**



GlacialPower<sup>®</sup>  
Power Your Idea