



Power Your Idea

GlacialPower CC Driver Solutions

LED 電源 產品 目錄 2020 November



<p>▲ LED CC Driver-Plastic Housing</p> <p>CC - IP 02</p> <p>GP-HS Series (4W ~ 60W)</p> <p>GP-RS Series (Double Insulation Cable Wire, 12W ~ 60W)</p> <p>GP-LC Series (2.4W ~ 20W)</p> <p>GP-LS Series (12W ~ 33W)</p> <p>GP-LE Series (33W ~ 60W)</p> <p>GP-LP Series (60W ~ 75W)</p> <p>CC Terminal Block Type 14</p> <p>GP-LC Series (3W ~ 25W)</p> <p>CC Dimming (2/3-in-1) 15</p> <p>GP-HS Series (8W ~ 60W)</p> <p>GP-RS Series (Double Insulation Cable Wire, 8W ~ 60W)</p> <p>GP-LP Series (60W ~ 75W)</p> <p>CC Dimming (Triac) 21</p> <p>GP-TS Series (8W ~ 12W, 90Vac ~ 130Vac)</p> <p>GP-TS Series (8W ~ 12W, 180Vac ~ 264Vac)</p> <p>GP-TL Series (9W ~ 24W, 108Vac ~ 132Vac)</p> <p>GP-TH Series (9W ~ 24W, 207Vac ~ 253Vac)</p> <p>CC - DC Jack Connector 26</p> <p>GP-HS15P Series (15W)</p> <p>GP-RS35P Series (Double Insulation Cable Wire, 35W)</p> <p>Multiple CC+CV 28</p> <p>GP-LC7028-Q5D (20W)</p>	
<p>▲ LED CC Driver - Metal Housing</p> <p>CC - IP 29</p> <p>GP-LS Series (40W ~ 200W)</p> <p>CC- Terminal Blocks Type 32</p> <p>GP-LC Series (48W)</p> <p>CC Dimming (3-in-1) 33</p> <p>GP-LS Series (40W ~ 60W)</p> <p>CC - High Voltage Output 34</p> <p>GP-LS Series (70W ~ 150W)</p> <p>CC Dimming - High Voltage Output..... 35</p> <p>GP-LS Series (150W)</p> <p>CC - IP68 Cable Connector 36</p> <p>GP-LS Series (60W ~200W)</p>	

GP-HS Series (4W ~ 60W)



GP-HS05N Series

Universal AC Input 90~264VAC.
 Protections: OCP/ SCP.
 Cooling by Free Air Convection.

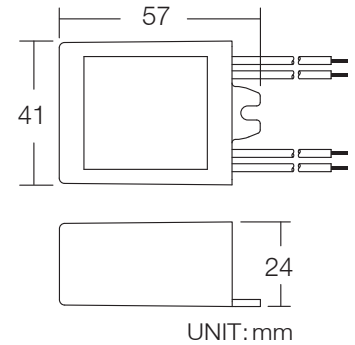

Model No. 型號	Output Voltage 輸出電壓	Rated Current 額定電流	Efficiency 效率	Tolerance(A) 公差	Watts 瓦
GP-HS05N-07C	5~7.5V	700mA	70%	± 7%	5.2W
GP-HS05N-12C1	3~11.6V	400mA	70%	± 10%	4.6W
GP-HS05N-12C	7~12V	350mA	70%	± 7%	4.2W
GP-HS05N-24C	15~24V	200mA	70%	± 7%	4.8W

CE FC LPS SELV EQUIVALENT IP67  

GP-HS08N Series



Universal AC Input from 90~295VAC.
 Protections: OCP / SCP.
 Complete Rated Current from 250mA~680mA.
 No Load Consumption < 0.5W.
 Set Up Time < 0.5 Sec at 230VAC.
 Compliant with ErP EU_1194_2012, Stage 3 Directives
 for Energy Related Products.

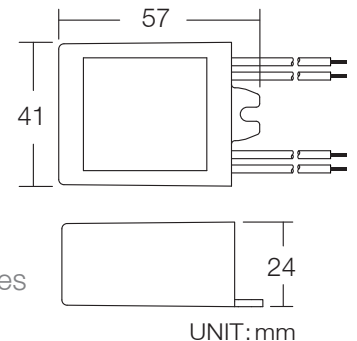

Model No. 型號	Output Voltage 輸出電壓	Rated Current 額定電流	Efficiency 效率	Tolerance(A) 公差	Watts 瓦
GP-HS08N-11C	2~11V	680mA	73%	± 7%	7.4W
GP-HS08N-14C	2~14.5V	500mA	75%	± 7%	7.2W
GP-HS08N-21C	4~21V	350mA	75%	± 7%	7.3W
GP-HS08N-21C1	10~24V	300mA	75%	± 7%	7.2W
GP-HS08N-28C	14~28V	250mA	78%	± 7%	7W

CE FC LPS SELV EQUIVALENT IP67  

*All the specifications subject to change without notice.

GP-HS Series (4W ~ 60W)**GP-HS10P Series**

Universal AC Input 90~264VAC.
 Operation from -20°C~60°C Full Load.
 Protections: OTP / SCP.
 Class II Power Design Without Earth Pin.

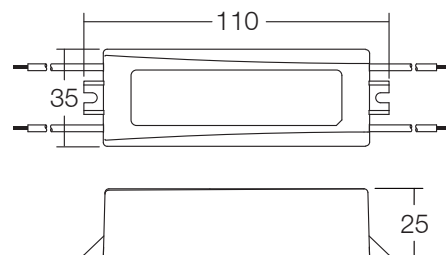

UNIT:mm

Model No. 型號	Output Voltage 輸出電壓	Rated Current 額定電流	Efficiency 效率	Tolerance(A) 公差	Watts 瓦
GP-HS10P-12C	8~12VDC	1000mA	81%	± 5%	12W
GP-HS10P-24C	14~24VDC	500mA	83%	± 5%	12W
GP-HS10P-24C2	14~27VDC	350mA	82%	± 5%	9.5W
GP-HS10P-36C1	24~36VDC	270mA	81%	± 5%	9.7W
GP-HS10P-36C2	20~36VDC	350mA	83%	± 5%	12.6W
GP-HS10P-48C	26~48VDC	250mA	84%	± 5%	12W
GP-HS10P-48C1	26~48VDC	270mA	81%	± 5%	12.9W
GP-HS10P-52C	30~52VDC	230mA	84%	± 5%	11.96W

CE FC cUL^{us} SELV IP67

**GP-HS15P Series**

Universal AC Input 90~264VAC.
 Built-in Constant Current Limiting Design.
 Operation from -20°C~60°C Full Load.
 Protections: OTP / SCP.
 Class II Power Design Without Earth Pin.

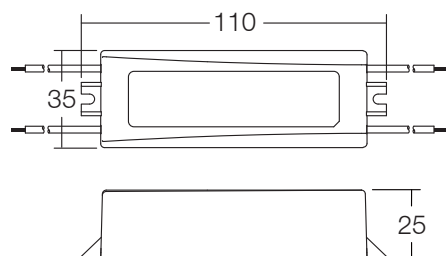

UNIT:mm

Model No. 型號	Output Voltage 輸出電壓	Rated Current 額定電流	Efficiency 效率	Tolerance(A) 公差	Watts 瓦
GP-HS15P-12C	8~12VDC	1250mA	81%	± 5%	15W
GP-HS15P-22C	14~22VDC	700mA	83%	± 5%	15.4W
GP-HS15P-22C1	14~24VDC	700mA	83%	± 5%	16.8W
GP-HS15P-30C	24~30VDC	500mA	83%	± 5%	15W
GP-HS15P-36C	24~36VDC	450mA	83%	± 5%	16.2W
GP-HS15P-36C2	24~38VDC	420mA	83%	± 5%	15.96W
GP-HS15P-42C	26~42VDC	350mA	84%	± 5%	14.7W
GP-HS15P-48C	26~48VDC	300mA	84%	± 5%	14.4W
GP-HS15P-52C	30~52VDC	300mA	84%	± 5%	15.6W

CE FC cUL^{us} SELV IP67



GP-HS Series (4W ~ 60W)

GP-HS25P Series



Universal AC Input 90~295VAC.
 Built-in PFC Function.
 Protections: OTP / SCP / OVP.
 Operation From -20°C~50°C Full Load.
 Class 2 Power Supply Unit.

Model No. 型號	Output Voltage 輸出電壓	Rated Current 額定電流	Efficiency 效率	Tolerance(A) 公差	Watts 瓦
GP-HS25P-12C	8~12VDC	2100mA	82%	± 8%	25.2W
GP-HS25P-18C	12~18VDC	1400mA	83%	± 8%	25.2W
GP-HS25P-24C	16~24VDC	1050mA	84%	± 8%	25.2W
GP-HS25P-36C	21~36VDC	700mA	85%	± 8%	25.2W
GP-HS25P-36C1	21~38VDC	660mA	85%	± 8%	25.08W
GP-HS25P-48C1	33~42VDC	600mA	84%	± 8%	25.2W
GP-HS25P-48C	35~48VDC	520mA	85%	± 8%	24.9W
GP-HS25P-52C	42~52VDC	480mA	85%	± 8%	24.9W
GP-HS25P-52C1	42~52VDC	350mA	82%	± 8%	18.2W

CE FC C SELV EQUIVALENT IP67 (for 48V/52V only)

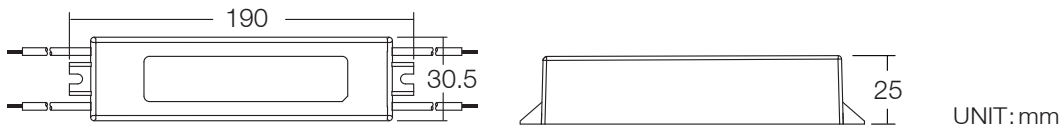

GP-HS35P-48C (CV+CC)



Universal AC Input 90~305VAC.
 Constant Voltage / Constant Current Operation.
 Built-in PFC Function.
 Protections: OVP / SCP / OTP.
 Operation From -20°C ~50°C Full Load.
 Class 2 Power Supply Unit.

Model No. 型號	Output Voltage 輸出電壓	Rated Current 額定電流	Efficiency 效率	Tolerance(A) 公差	Watts 瓦
GP-HS35P-48C	33~48VDC	700mA	83%	± 5%	33.6W

CE FC SELV EQUIVALENT C IP67

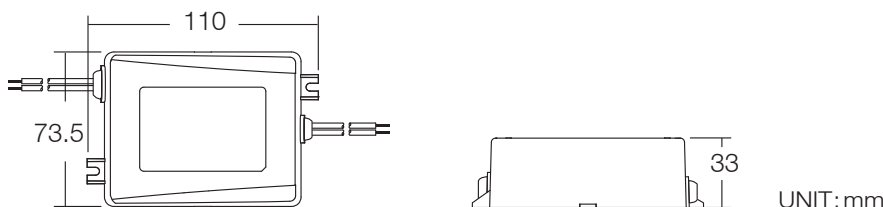

GP-HS Series (4W ~ 60W)

**GP-HS60P-24C1**

Universal AC Input 90~305VAC.
Built-in PFC Function.
Protections: OVP / OCP / SCP / OTP.
Class II/2 Power.

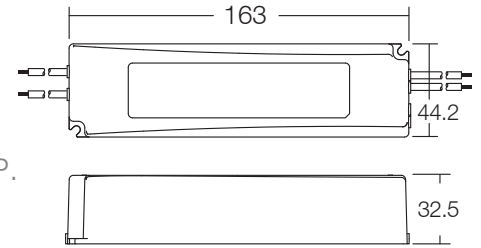

UNIT:mm

Model No. 型號	Output Voltage 輸出電壓	Rated Current 額定電流	Efficiency 效率	Tolerance(A) 公差	Watts 瓦
GP-HS60P-24C1	16~24V	2.2A	86%	± 5%	52.8W

CE FC cULus SELV IP67
EQUIVALENT

**GP-HS60P-42C1**

Universal AC Input 90 ~ 305VAC.
Built-in Active PFC Function.
Protections: OVP / OCP / SCP / OTP.
No Load Consumption < 0.5W.
Set up Time < 0.5 Sec at 230VAC.
Class II/2 Power.

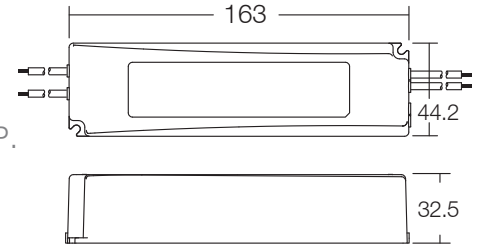

UNIT:mm

Model No. 型號	Output Voltage 輸出電壓	Rated Current 額定電流	Efficiency 效率	Tolerance(A) 公差	Watts 瓦
GP-HS60P-42C1	28~42V	1.4A	87%	± 5%	58.8W

CE FC SELV IP67
EQUIVALENT

**GP-HS60P-48C**

Universal AC Input 90~305VAC.
Built-in PFC Function.
Protections: OVP / OCP / SCP / OTP.
Class II/2 Power.

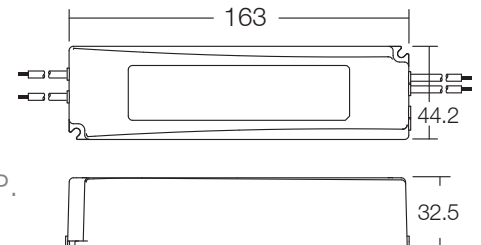

UNIT:mm

Model No. 型號	Output Voltage 輸出電壓	Rated Current 額定電流	Efficiency 效率	Tolerance(A) 公差	Watts 瓦
GP-HS60P-48C	33~48V	1.2A	88%	± 5%	57.6W

CE FC cULus SELV IP67
EQUIVALENT

GP-RS Series (Double Insulation Cable Wire, 12W~60W)



GP-RS10P Series

Universal AC Input 90~264VAC.
 No Load Consumption < 0.5W
 Meet Application For ErP EU_1194_2012,Stage 3.
 Operation from -20°C ~60°C Full Load.
 Protections: OTP / SCP.
 Class II Power Design Without Earth Pin.

Model No. 型號	Output Voltage 輸出電壓	Rated Current 額定電流	Efficiency 效率	Tolerance(A) 公差	Watts 瓦
GP-RS10P-12C	8-12VDC	1000mA	81%	± 5%	12W
GP-RS10P-24C	14-24VDC	500mA	83%	± 5%	12W
GP-RS10P-36C	24-36VDC	350mA	83%	± 5%	12.6W
GP-RS10P-48C	26-48VDC	250mA	84%	± 5%	12W

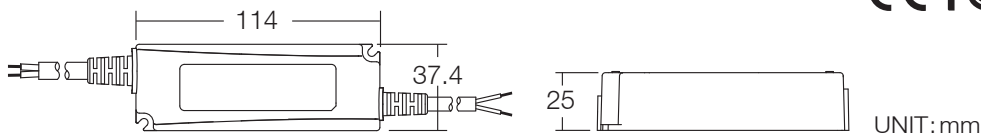

GP-RS15P Series

Universal AC Input 90~264VAC.
 No Load Consumption < 0.5W
 Meet Application For ErP EU_1194_2012,Stage 3.
 Operation from -20°C~60°C Full Load.
 Protections: OTP / SCP.
 Class II Power Design Without Earth Pin.



Model No. 型號	Output Voltage 輸出電壓	Rated Current 額定電流	Efficiency 效率	Tolerance(A) 公差	Watts 瓦
GP-RS15P-12C	8~12VDC	1250mA	81%	± 5%	15W
GP-RS15P-22C	14~22VDC	700mA	83%	± 5%	15.4W
GP-RS15P-30C	24~30VDC	500mA	83%	± 5%	15W
GP-RS15P-42C	26~42VDC	350mA	84%	± 5%	14.7W

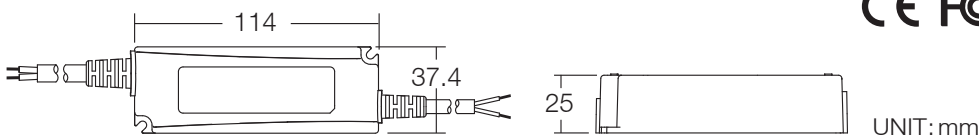

GP-RS Series (Double Insulation Cable Wire, 12W~60W)**GP-RS26P Series (CV + CC)**

Universal AC Input 90~305VAC.

Built-in PFC Function.

Protections: OVP / SCP / OTP.

Operation From -20°C ~50°C Full Load.

Constant Voltage / Constant Current Operation.

Class 2 Power Supply Unit.

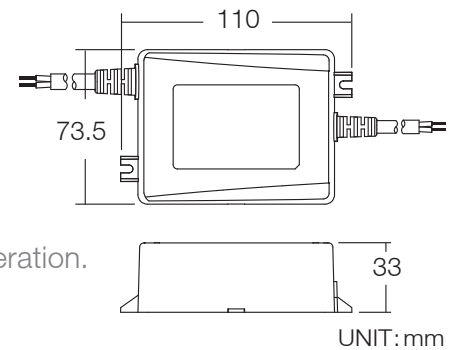

Model No. 型號	Output Voltage 輸出電壓	Rated Current 額定電流	Efficiency 效率	Tolerance(A) 公差	Watts 瓦
GP-RS26P-12C	9~12VDC	2100mA	79%	± 5%	25.2W
GP-RS26P-24C	14~24VDC	1050mA	80%	± 5%	25.2W
GP-RS26P-36C	24~36VDC	700mA	80%	± 5%	25.2W
GP-RS26P-42C	33~42VDC	600mA	80%	± 5%	25.2W
GP-RS26P-48C	33~48VDC	500mA	80%	± 5%	24W
GP-RS26P-57C	40~57VDC	350mA	78%	± 5%	20W

CE FC cULus SELV IP67  

**GP-RS35P Series (CV + CC)**

Universal AC Input 90~305VAC.

Built-in PFC Function.

Protections: OVP / SCP / OTP.

Operation From -20°C ~50°C Full Load.

Constant Voltage / Constant Current Operation.

Class 2 Power Supply Unit.

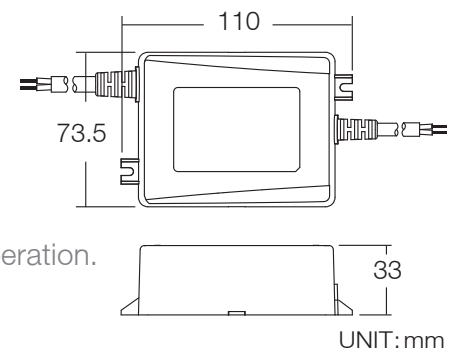

Model No. 型號	Output Voltage 輸出電壓	Rated Current 額定電流	Efficiency 效率	Tolerance(A) 公差	Watts 瓦
GP-RS35P-12C	9~12VDC	2500mA	80%	± 5%	30W
GP-RS35P-24C	14~24VDC	1400mA	81%	± 5%	33.6W
GP-RS35P-36C	24~36VDC	1000mA	82%	± 5%	36W
GP-RS35P-42C	33~42VDC	800mA	82%	± 5%	33.6W
GP-RS35P-48C	33~48VDC	700mA	83%	± 5%	33.6W
GP-RS35P-57C	40~57VDC	500mA	82%	± 5%	28.5W

CE FC cULus SELV IP67  

GP-RS Series (Double Insulation Cable Wire, 12W~60W)



GP-RS45P Series

Universal AC Input 90~305VAC.

Built-in PFC Function.

Protections: OVP / OCP / SCP / OTP .

Class II/2 Power

Model No. 型號	Output Voltage 輸出電壓	Rated Current 額定電流	Efficiency 效率	Tolerance(A) 公差	Watts 瓦
GP-RS45P-24C	16~24VDC	1.85A	85%	± 5%	44.4W
GP-RS45P-36C	24~36VDC	1.25A	86%	± 5%	45W
GP-RS45P-42C	33~42VDC	1.05A	86%	± 5%	44.1W
GP-RS45P-48C	33~48VDC	1A	87%	± 5%	48W
GP-RS45P-57C	40~57VDC	0.7A	87%	± 5%	40W

CE FC cULus SELV IP67 F 110

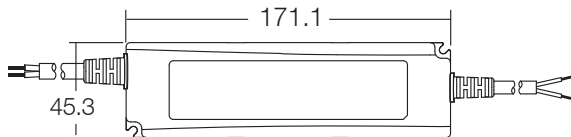

GP-RS60P Series

Universal AC Input 90~305VAC.

Built-in PFC Function.

Protections: OVP / OCP / SCP / OTP .

Class II/2 Power



Model No. 型號	Output Voltage 輸出電壓	Rated Current 額定電流	Efficiency 效率	Tolerance(A) 公差	Watts 瓦
GP-RS60P-12C	9~12VDC	4.2A	86%	± 5%	50.4W
GP-RS60P-24C	16~24VDC	2.5A	86%	± 5%	60W
GP-RS60P-36C	24~36VDC	1.65A	87%	± 5%	59.4W
GP-RS60P-42C	33~42VDC	1.4A	87%	± 5%	58.8W
GP-RS60P-48C	33~48VDC	1.2A	88%	± 5%	57.6W
GP-RS60P-57C	40~57VDC	1.05A	88%	± 5%	59.8W

CE FC cULus SELV IP67 F 110

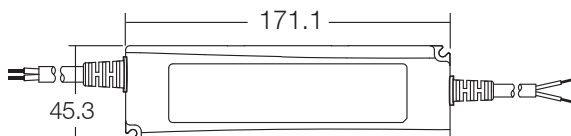

GP-LC Series (2.4W ~ 20W)**GP-LCxxxx-06 Series**

Universal AC Input 90~264VAC.
 Operation from -10°C ~40°C Full Load.
 Protections: OVP/OLP/ SCP.
 Class II Power Design Without Earth Pin.

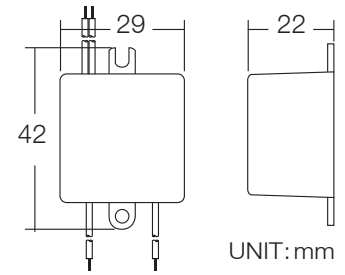

Model No. 型號	Output Voltage 輸出電壓	Rated Current 額定電流	Tolerance(A) 公差	Watts 瓦
GP-LC3512-06	3~8VDC	350mA	± 6%	2.4W
GP-LC3513-06	6~12VDC	350mA	± 6%	3.6W
GP-LC7012-06	3~5VDC	700mA	± 6%	3W

**GP-LCxxxx-02 Series**

Universal AC Input 90~264VAC.
 Operation from -10°C~40°C Full Load.
 Protections: OVP / OLP/ SCP.
 Class II Power Design Without Earth Pin.

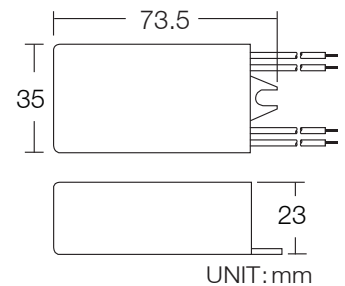

Model No. 型號	Output Voltage 輸出電壓	Rated Current 額定電流	Tolerance(A) 公差	Watts 瓦
GP-LC3536-02	3~36VDC	350mA	± 6%	8W
GP-LC7021-02	3~21VDC	700mA	± 6%	9W

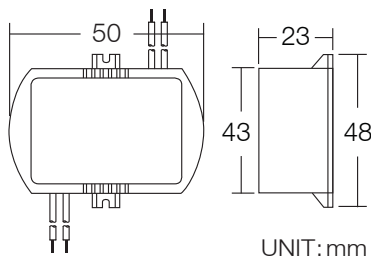
**GP-LCxxxx-08 Series**

Universal AC Input 90~264VAC.
 Operation from -10°C~40°C Full Load.
 Protections: OVP / OLP/ SCP.
 Class II Power Design Without Earth Pin.



Model No. 型號	Output Voltage 輸出電壓	Rated Current 額定電流	Tolerance(A) 公差	Watts 瓦
GP-LC3536-08	3~36VDC	350mA	± 6%	8W
GP-LC7021-08	3~21VDC	700mA	± 6%	9W



GP-LC Series (2.4W ~ 20W)



GP-LC3536-05 Series

Universal AC Input 90~264VAC.

Protections:OTP/OLP/ SCP.

Operation from -20°C~50°C at Full Load.

Class II Power Design Without Earth Pin.

Tc Point Measured ,Max Case Temperature:70°C.

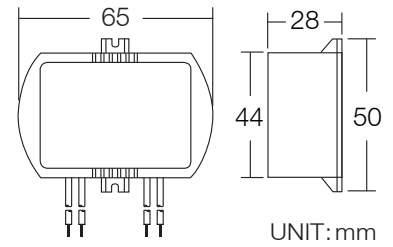

UNIT:mm

Model No. 型號	Output Voltage 輸出電壓	Rated Current 額定電流	Tolerance(A) 公差	Watts 瓦
GP-LC3536-05	3~36VDC	350mA	± 6%	12W

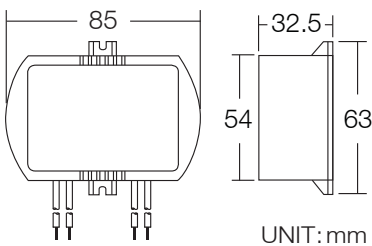

UNIT:mm

GP-LCxxxx-15 Series

Universal AC Input Range (up to 264VAC).

Class 2 Power Supply Unit.

Built-in Active PFC Function.

Protections: SCP / OCP.



Model No. 型號	Output Voltage 輸出電壓	Rated Current 額定電流	Tolerance(A) 公差	Watts 瓦
GP-LC5026-15	10~26VDC	500mA	± 6%	13W
GP-LC3554-15	10~54VDC	350mA	± 6%	16W



GP-LC3556-15	32~56VDC	350mA	± 6%	20W
GP-LC7034-15	20~34VDC	700mA	± 6%	20W



GP-LS Series (12W ~ 33W)

GP-LS10P Series



Universal AC Input 90~264VAC.
 Operation from -20°C~70°C Full Load.
 Protections: OVP / OLP/ SCP.
 Class II Power Design Without Earth Pin.
 Cooling by Free Air Convection.
 UL1310 Class 2 Power Unit .

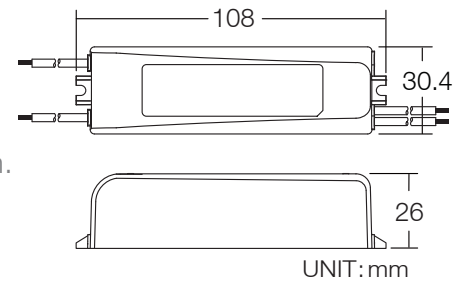

Model No. 型號	Output Voltage 輸出電壓	Rated Current 額定電流	Efficiency 效率	Tolerance(A) 公差	Watts 瓦
GP-LS10P-36	18~36VDC	340mA	84%	± 10%	12W
GP-LS10P-18	9~18VDC	680mA	81%	± 10%	12W

CE FC IP67 SELV   

GP-LS10P-xxA Series



Universal AC Input 90~264VAC.
 Operation from -20°C~70°C Full Load.
 Protections: OVP/OLP/SCP.
 Class II Power Design Without Earth Pin.
 Cooling by Free Air Convection.
 UL1310 Class 2 Power Unit.
 Dimming Control by External Voltage of PWM or Analog.

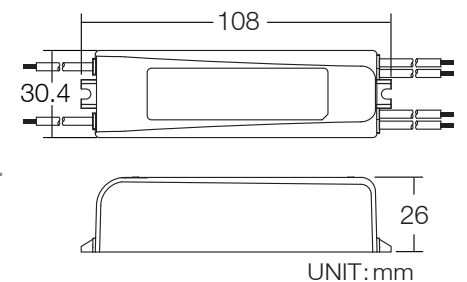

Model No. 型號	Output Voltage 輸出電壓	Rated Current 額定電流	Efficiency 效率	Tolerance(A) 公差	Watts 瓦
GP-LS10P-35A	4~35VDC	340mA	80%	± 10%	12W
GP-LS10P-17A	4~17VDC	680mA	80%	± 10%	12W

CE FC IP67 SELV   

GP-LS35P Series



Universal AC Input 90~264VAC.
 Built-in PFC Function.
 Protections: OVP / OCP / SCP / OTP.
 Cooling by Free Air Convection.
 Class 2 Power Supply Unit.
 Withstand 277VAC Surge Input for 10 Sec.

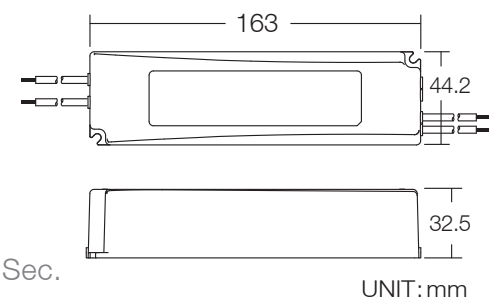

Model No. 型號	Output Voltage 輸出電壓	Rated Current 額定電流	Efficiency 效率	Tolerance(A) 公差	Watts 瓦
GP-LS35P-48	5~48VDC	700mA	86%	± 10%	33.6W
GP-LS35P-30	5~30VDC	1050mA	85%	± 10%	31.5W

CE FC IP67 SELV   

12 LED CC Driver - Plastic Housing **CC-IP**
 GP-LS Series (12W ~ 33W)

GP-LS35P-xxA Series



Universal AC Input 90~264VAC.
 Dimming Type: PWM/ DC.
 Built-in PFC Function.
 Protections: OVP / OCP / SCP / OTP.
 Cooling by Free Air Convection.
 Class 2 Power Supply Unit.
 Withstand 277VAC Surge Input for 10 Sec.

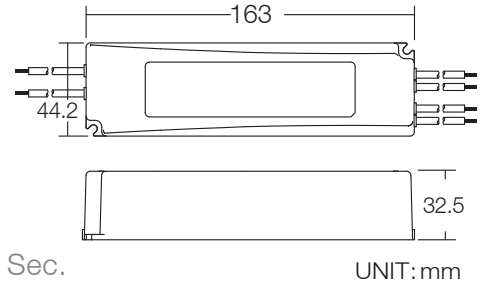

Model No. 型號	Output Voltage 輸出電壓	Rated Current 額定電流	Efficiency 效率	Tolerance(A) 公差	Watts 瓦
GP-LS35P-42A	5~42VDC	700mA	84%	± 10%	29.4W



GP-LE Series (33W ~ 60W)



GP-LE036N Series

Universal AC Input 90~264VAC.
 Operation from -20°C~40°C Full Load.
 Protections: OTP / OLP/ SCP.
 Class II Power Design Without Earth Pin.

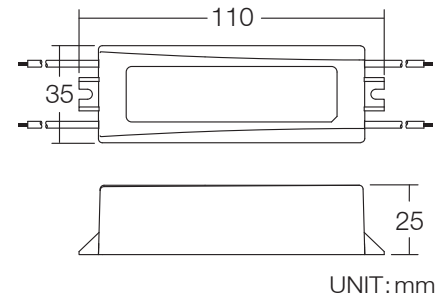

Model No. 型號	Output Voltage 輸出電壓	Rated Current 額定電流	Efficiency 效率	Tolerance(A) 公差	Watts 瓦
GP-LE036N-36C	24~36VDC	1.05A	85%	± 8%	37.8W
GP-LE036N-48C	36~48VDC	700mA	85%	± 8%	33.6W



GP-LE060N Series

Universal AC Input 90~264VAC.
 Operation from -20°C~40°C Full Load.
 Protections: OTP / OLP/ SCP/ OVP.
 Class II Power Design Without Earth Pin.

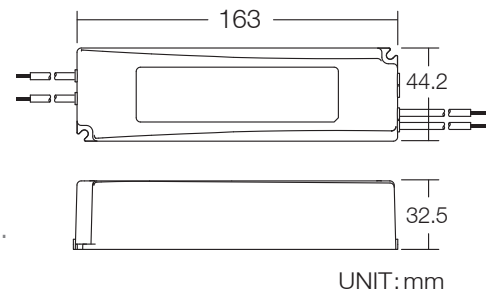

Model No. 型號	Output Voltage 輸出電壓	Rated Current 額定電流	Efficiency 效率	Tolerance(A) 公差	Watts 瓦
GP-LE060N-36C	25~36VDC	1.67A	85%	± 8%	60W
GP-LE060N-42C	28~42VDC	1.4A	85%	± 8%	58.8W
GP-LE060N-48C	32~48VDC	1.05A	85%	± 8%	50.4W





GP-LP060P Series (CV + CC)

Universal AC Input 90~305VAC.
 Class 2 Power Supply Unit.
 Built-in PFC Function.
 Protections: OVP / OCP / SCP / OTP.
 Cooling by Free Air Convection.

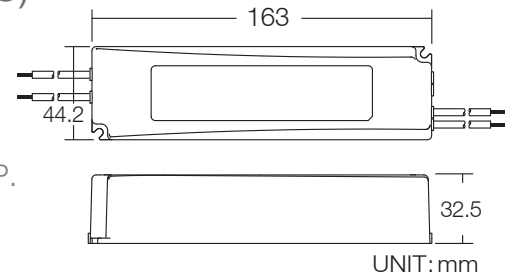

Model No. 型號	Output Voltage 輸出電壓	Rated Current 額定電流	Efficiency 效率	Tolerance(A) 公差	Watts 瓦
GP-LP060P-24	12~24VDC	2500mA	87%	± 5%	60W
GP-LP060P-36	24~36VDC	1700mA	87%	± 5%	61W
GP-LP060P-48	36~48VDC	1250mA	87%	± 5%	60W



GP-LP075P Series (CV + CC)

Universal AC Input 90~305VAC.
 Class 2 Power Supply Unit.
 Built-in PFC Function.
 Protections: OVP / OCP / SCP / OTP.
 Cooling by Free Air Convection.

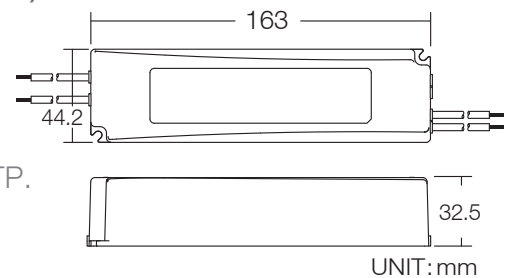

Model No. 型號	Output Voltage 輸出電壓	Rated Current 額定電流	Efficiency 效率	Tolerance(A) 公差	Watts 瓦
GP-LP075P-24	12~24VDC	3125mA	87%	± 5%	75W
GP-LP075P-28	20~28VDC	2670mA	87%	± 5%	75W
GP-LP075P-36	24~36VDC	2080mA	87%	± 5%	75W
GP-LP075P-48	36~48VDC	1560mA	87%	± 5%	75W



GP-LC Series (3W ~ 25W)



GP-LCxxxx-01 Series

Universal AC Input 90~264VAC.
 Operation from -10°C~40°C Full Load.
 Protections: OVP / OLP/ SCP.
 Class II Power Design Without Earth Pin.

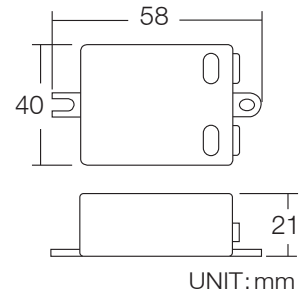

Model No. 型號	Output Voltage 輸出電壓	Rated Current 額定電流	Tolerance(A) 公差	Watts 瓦
GP-LC3512-01	3~12VDC	350mA	± 6%	3W
GP-LC7012-01	3~12VDC	700mA	± 6%	6W



GP-LCxxxx-03 Series

Universal AC Input 90~264VAC.
 Operation from -10°C~40°C Full Load.
 Protections: OVP / OLP/ SCP.
 Class II Power Design Without Earth Pin.

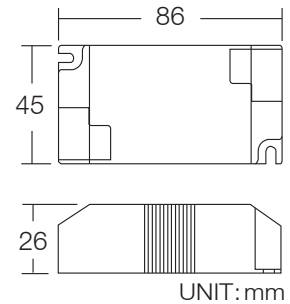

Model No. 型號	Output Voltage 輸出電壓	Rated Current 額定電流	Tolerance(A) 公差	Watts 瓦
GP-LC3512-03	3~12VDC	350mA	± 6%	3W
GP-LC3522-03	3~22VDC	350mA	± 6%	6W
GP-LC3536-03	3~36VDC	350mA	± 6%	8W
GP-LC7021-03	3~21VDC	700mA	± 6%	9W



GP-LCxxxx-04 Series

Universal Input Range from 90~264VAC.
 Terminal Screw for Safe Connection.
 With PFC Function Design.
 IP20 for Dry Location.
 Protection : Auto-Recovery Mode.
 Protections: Short-Circuit / Over Load / Over Heat.

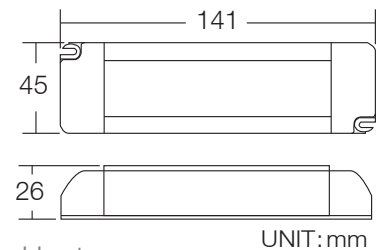

Model No. 型號	Output Voltage 輸出電壓	Rated Current 額定電流	Tolerance(A) 公差	Watts 瓦
GP-LC3554-04	10~54VDC	350mA	± 6%	16W
GP-LC5050-04	36~50VDC	500mA	± 6%	25W
GP-LC7034-04	3~34VDC	700mA	± 6%	18W
GP-LC7036-04	25~36VDC	700mA	± 6%	25W
GP-LCA025-04	15~25VDC	1000mA	± 6%	25W



GP-HS Series (8W ~ 60W)

GP-HS10P-xxCA / GP-HS15P-xxCA Series



Universal AC Input 90~264VAC.
Built-in 3-in-1 Dimming Design.
Operation from -20°C ~60°C Full Load.
Protections: OTP / SCP.
Class II Power Design Without Earth Pin.

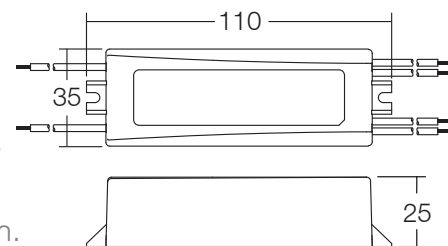

UNIT:mm

Model No. 型號	Output Voltage 輸出電壓	Rated Current 額定電流	Efficiency 效率	Tolerance(A) 公差	Watts 瓦
GP-HS10P-12CA	8~12VDC	1000mA	79%	± 5%	12W
GP-HS10P-24CA	14~24VDC	500mA	82%	± 5%	12W
GP-HS10P-24CA1	14~24VDC	350mA	80%	± 5%	8.4W
GP-HS10P-24CA2	14~27VDC	350mA	80%	± 5%	9.5W
GP-HS10P-36CA	24~36VDC	350mA	81%	± 5%	12.6W
GP-HS10P-36CA2	20~36VDC	350mA	81%	± 5%	12.6W
GP-HS10P-48CA	26~48VDC	250mA	81%	± 5%	12W

GP-HS15P-12CA	8~12VDC	1250mA	80%	± 5%	15W
GP-HS15P-24CA	14~24VDC	700mA	83%	± 5%	16.8W
GP-HS15P-30CA	24~30VDC	500mA	83%	± 5%	15W
GP-HS15P-42CA	26~42VDC	350mA	82%	± 5%	14.7W

CE FC SELV IP67

GP-HS35P-48CA Series



Universal AC Input 90-305VAC.
Built-in Active PFC Function.
Protections: OVP, SCP, OTP.
3-in-1 Dimming Function
(DC 1-10 V, PWM, and Resistor).
Fully Isolated Plastic Case.
Operation From -20°C ~50°C Full Load.
Class 2 Power Supply Unit.

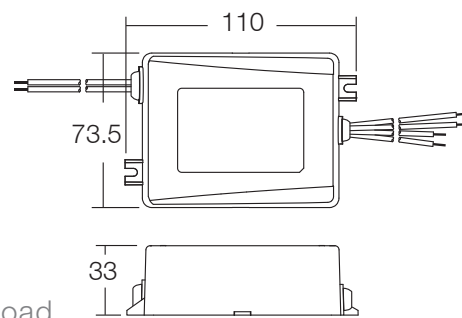

UNIT:mm

Model No. 型號	Output Voltage 輸出電壓	Rated Current 額定電流	Efficiency 效率	Tolerance(A) 公差	Watts 瓦
GP-HS35P-48CA	33~48VDC	700mA	83%	± 5%	33.6W

CE FC SELV EQUIVALENT C UL US IP67

16 LED CC Driver - Plastic Housing
GP-HS Series (8W ~ 60W)

CC Dimming (3-in-1)



GP-HS60P-24CA1

Universal AC Input 90~305VAC.
Built-in PFC Function.
Protections: OVP / OCP / SCP / OTP.
Built-in 3-in-1 Dimming Function.
Class II Power.

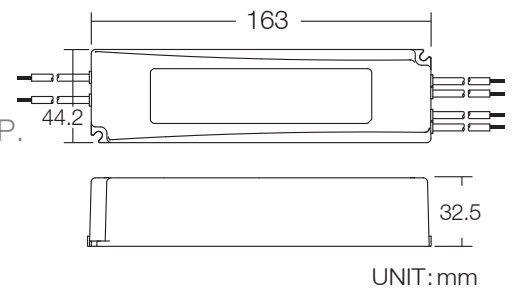

UNIT:mm

Model No. 型號	Output Voltage 輸出電壓	Rated Current 額定電流	Efficiency 效率	Tolerance(A) 公差	Watts 瓦
GP-HS60P-24CA1	16~24VDC	2.2A	86%	± 5%	52.8W

CE FC SELV EQUIVALENT IP67



GP-HS60P-42CA1

Universal AC Input 90~305VAC.
Built-in Active PFC Function.
Protections: OVP / OCP / SCP / OTP.
Built-in 3-in-1 Dimming Function.
Class II Power.
THD < 20% at 230VAC.
No Load Consumption < 0.5W.
Set Up Time < 0.5 Sec at 230VAC.
Meet Application for ErP EU_1194_2012,Stage 3.

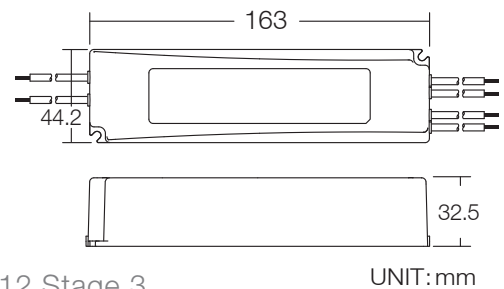

UNIT:mm

Model No. 型號	Output Voltage 輸出電壓	Rated Current 額定電流	Efficiency 效率	Tolerance(A) 公差	Watts 瓦
GP-HS60P-42CA1	28~42VDC	1.4A	87%	± 5%	58.8W

CE FC SELV EQUIVALENT IP67



GP-HS60P-42CA2

Universal AC input 90~305VAC.
Built-in Active PFC Function.
Protections: OVP / OCP / SCP / OTP.
Built-in 3-in-1 Dimming Function.
Class II Power.
THD < 20% at 230VAC.
No Load Consumption < 0.5W.
Set up time < 0.5 Sec at 230VAC.
Meet application for ErP EU_1194_2012,Stage 3.

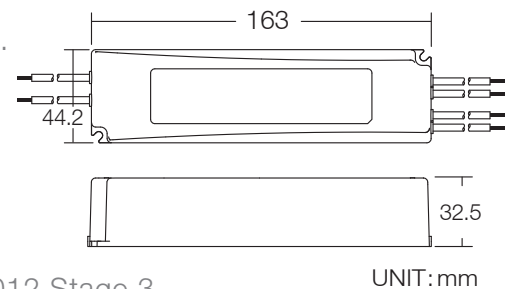

UNIT:mm

Model No. 型號	Output Voltage 輸出電壓	Rated Current 額定電流	Efficiency 效率	Tolerance(A) 公差	Watts 瓦
GP-HS60P-42CA2	28~42VDC	1.2A	87%	± 5%	50.4W

CE FC SELV EQUIVALENT IP67



GP-RS10P-xxCA Series

Universal AC Input 90~264VAC.
 No Load Consumption < 0.5W.
 Built-in 3-in-1 Dimming Design.
 Meet Application For ErP EU_1194_2012, Stage 3.
 Operation from -20°C ~60°C Full Load.
 Protections: OTP / SCP.
 Class II Power Design Without Earth Pin.

Model No. 型號	Output Voltage 輸出電壓	Rated Current 額定電流	Efficiency 效率	Tolerance(A) 公差	Watts 瓦
GP-RS10P-24CA1	14-24VDC	350mA	80%	± 5%	8.4W
GP-RS10P-36CA	24-36VDC	350mA	81%	± 5%	12.6W

CE FC SELV IP67   

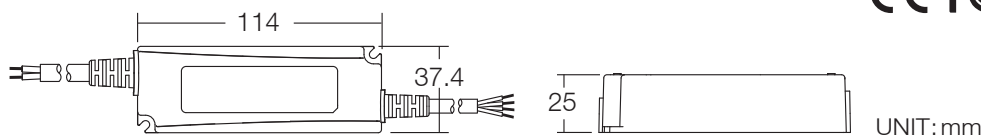

GP-RS15P Series

Universal AC Input 90~264VAC.
 No Load Consumption < 0.5W.
 Built-in 3-in-1 Dimming Design.
 Meet Application For ErP EU_1194_2012, Stage 3.
 Operation from -20°C~60°C Full Load.
 Protections: OTP / SCP.
 Class II Power Design Without Earth Pin.



Model No. 型號	Output Voltage 輸出電壓	Rated Current 額定電流	Efficiency 效率	Tolerance(A) 公差	Watts 瓦
GP-RS15P-12CA	8~12VDC	1250mA	80%	± 5%	15W
GP-RS15P-24CA	14~24VDC	700mA	83%	± 5%	16.8W
GP-RS15P-30CA	24~30VDC	500mA	83%	± 5%	15W
GP-RS15P-42CA	26~42VDC	350mA	82%	± 5%	14.7W

CE FC SELV IP67   

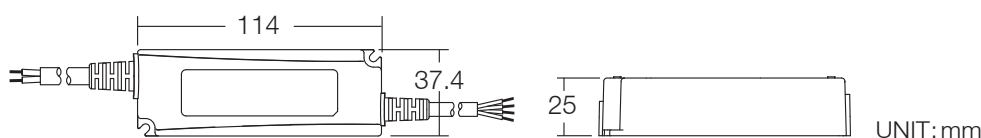

18 LED CC Driver - Plastic Housing **CC Dimming (3-in-1)**
 GP-RS Series (Double Insulation Cable Wire, 8W ~ 60W)



GP-RS26P-xxCA Series (CV + CC)

Universal AC Input 90~305VAC.
 Built-in PFC Function.
 Built-in 3-in-1 Dimming Design.
 Double Insulation Cable Wire.
 Protections: OVP / SCP / OTP.
 Operation From -20°C ~50°C Full Load.
 Class 2 Power Supply Unit.

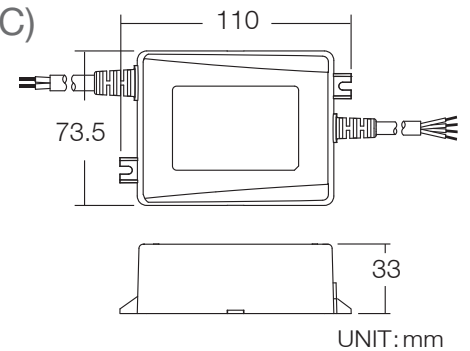

Model No. 型號	Output Voltage 輸出電壓	Rated Current 額定電流	Efficiency 效率	Tolerance(A) 公差	Watts 瓦
GP-RS26P-12CA	9~12VDC	2100mA	79%	± 5%	25.2W
GP-RS26P-24CA	14~24VDC	1050mA	80%	± 5%	25.2W
GP-RS26P-36CA	24~36VDC	700mA	80%	± 5%	25.2W
GP-RS26P-42CA	33~42VDC	600mA	80%	± 5%	25.2W
GP-RS26P-48CA	33~48VDC	500mA	80%	± 5%	24W
GP-RS26P-57CA	40~57VDC	350mA	78%	± 5%	20W

CE FC cULus SELV IP67

GP-RS35P-xxCA Series (CV + CC)

Universal AC Input 90~305VAC.
 Built-in PFC Function.
 Built-in 3-in-1 Dimming Design.
 Double Insulation Cable Wire.
 Protections: OVP / SCP / OTP.
 Operation From -20°C ~50°C Full Load.
 Class 2 Power Supply Unit.

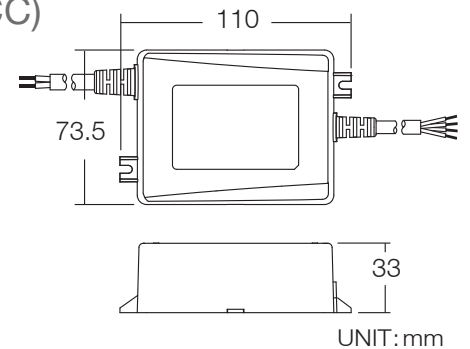

Model No. 型號	Output Voltage 輸出電壓	Rated Current 額定電流	Efficiency 效率	Tolerance(A) 公差	Watts 瓦
GP-RS35P-12CA	9~12VDC	2500mA	80%	± 5%	30W
GP-RS35P-24CA	14~24VDC	1400mA	81%	± 5%	33.6W
GP-RS35P-36CA	24~36VDC	1000mA	82%	± 5%	36W
GP-RS35P-42CA	33~42VDC	800mA	82%	± 5%	33.6W
GP-RS35P-48CA	33~48VDC	700mA	83%	± 5%	33.6W
GP-RS35P-57CA	40~57VDC	500mA	82%	± 5%	28.5W

CE FC cULus SELV IP67



GP-RS45P-xxCA Series

Universal AC Input 90~305VAC.
 Built-in PFC Function.
 Built-in 3-in-1 Dimming Design.
 Double Insulation Cable Wire.
 Protections: OVP / OCP / SCP / OTP .
 Class II/2 Power

Model No. 型號	Output Voltage 輸出電壓	Rated Current 額定電流	Efficiency 效率	Tolerance(A) 公差	Watts 瓦
GP-RS45P-24CA	16~24VDC	1.85A	85%	± 5%	44.4W
GP-RS45P-36CA	24~36VDC	1.25A	86%	± 5%	45W
GP-RS45P-42CA	33~42VDC	1.05A	86%	± 5%	44.1W
GP-RS45P-48CA	33~48VDC	1A	87%	± 5%	48W
GP-RS45P-57CA	40~57VDC	0.7A	87%	± 5%	40W

CE FC cULus SELV IP67 F 110

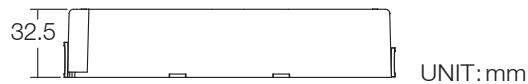
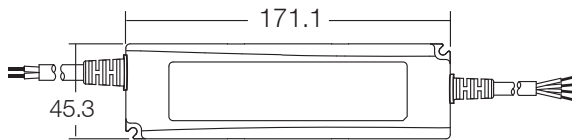

GP-RS60P-xxCA Series

Universal AC Input 90~305VAC.
 Built-in PFC Function.
 Built-in 3-in-1 Dimming Design.
 Double Insulation Cable Wire.
 Protections: OVP / OCP / SCP / OTP .
 Class II/2 Power

Model No. 型號	Output Voltage 輸出電壓	Rated Current 額定電流	Efficiency 效率	Tolerance(A) 公差	Watts 瓦
GP-RS60P-12CA	9~12VDC	4.2A	86%	± 5%	50.4W
GP-RS60P-24CA	16~24VDC	2.5A	86%	± 5%	60W
GP-RS60P-36CA	24~36VDC	1.65A	87%	± 5%	59.4W
GP-RS60P-42CA	33~42VDC	1.4A	87%	± 5%	58.8W
GP-RS60P-48CA	33~48VDC	1.2A	88%	± 5%	57.6W
GP-RS60P-57CA	40~57VDC	1.05A	88%	± 5%	59.8W

CE FC cULus SELV IP67 F 110

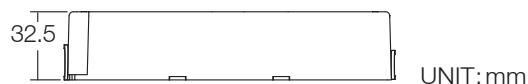
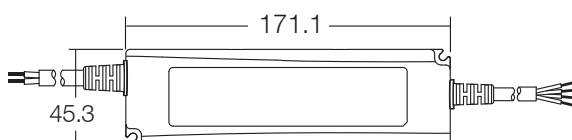



GP-LP060P-xxA Series

Universal AC Input 90~305VAC.
Class 2 Power Supply Unit.
Built-in PFC Function.
PWM / DC Dimming.
Protections: OVP / OCP / SCP / OTP.

Model No. 型號	Output Voltage 輸出電壓	Rated Current 額定電流	Efficiency 效率	Tolerance(A) 公差	Watts 瓦
GP-LP060P-24A	12~24VDC	2500mA	87%	± 5%	60W
GP-LP060P-36A	24~36VDC	1700mA	87%	± 5%	61W

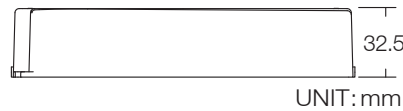
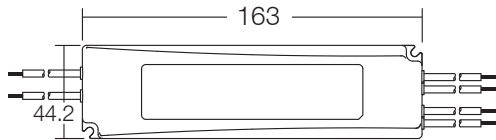

UNIT:mm



GP-LP075P-xxA Series

Universal AC Input 90~305VAC.
Class 2 Power Supply Unit.
Built-in PFC Function.
PWM / DC Dimming.
Protections: OVP / OCP / SCP / OTP.

Model No. 型號	Output Voltage 輸出電壓	Rated Current 額定電流	Efficiency 效率	Tolerance(A) 公差	Watts 瓦
GP-LP075P-24A	12~24VDC	3125mA	87%	± 5%	75W
GP-LP075P-28A	20~28VDC	2670mA	87%	± 5%	75W
GP-LP075P-36A	24~36VDC	2080mA	87%	± 5%	75W
GP-LP075P-48A	36~48VDC	1560mA	87%	± 5%	75W

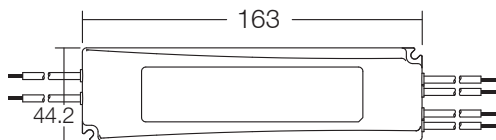

UNIT:mm



GP-TS10P-xxL Series

Dimmer Output Current Range from 10%~100%.
 Operation from -20°C~ 50°C Full Load.
 No Flicker With Adjust Luminance.
 Protections: SCP /OTP.
 Compatible With Most Standard Incandescent
 AC Triac Dimmers.

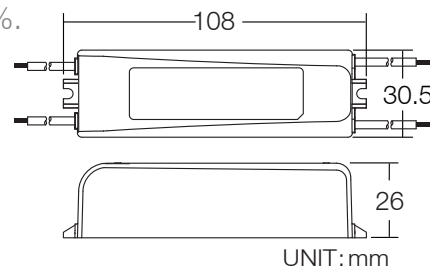

Model No. 型號	Output Voltage 輸出電壓	Rated Current 額定電流	Efficiency 效率	Tolerance(A) 公差	Watts 瓦
GP-TS10P-15L	7~15VDC	700mA	75%	± 7%	10.5W
GP-TS10P-21L	10~21VDC	500mA	76%	± 7%	10.5W
GP-TS10P-30L	15~30.5VDC	350mA	78%	± 10%	10.67W
GP-TS10P-30L1	15~30.5VDC	270mA	75%	± 10%	8.23W
GP-TS10P-42L	24~42VDC	270mA	78%	± 10%	11.34W

FC IP65   

GP-TS Series (8W ~ 12W, 180Vac ~ 264Vac)



GP-TS10P-xxH Series

Dimmer Output Current Range from 10%~100%.
 Operation from -20°C~ 50°C Full Load.
 No Flicker With Adjust Luminance.
 Protections: SCP /OTP.
 Compatible With Most Standard Incandescent
 AC Triac Dimmers.

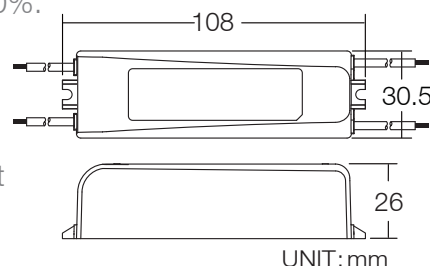

Model No. 型號	Output Voltage 輸出電壓	Rated Current 額定電流	Efficiency 效率	Tolerance 公差	Watts 瓦
GP-TS10P-15H	7~15VDC	700mA	75%	± 7%	10.5W
GP-TS10P-21H	10~21VDC	500mA	76%	± 7%	10.5W
GP-TS10P-30H	15~30.5VDC	350mA	78%	± 10%	10.67W
GP-TS10P-30H1	15~30.5VDC	270mA	75%	± 10%	8.23W
GP-TS10P-42H	24~42VDC	270mA	78%	± 10%	11.34W

CE IP65   

22 LED CC Driver - Plastic Housing **CC Triac Dimming**
 GP-TL Series (9W ~ 24W, 108Vac ~ 132Vac)



GP-TLxxxx-27 Series

Input Range from 120VAC \pm 10%.
 Work With Leading Edge and Trailing Edge Dimmers.
 With Power Factor Correction Function: PF > 0.9
 Designed for Indoor Application.
 Protections: Short-Circuit / Over Load.

Model No. 型號	Output Voltage 輸出電壓	Rated Current 額定電流	Efficiency 效率	Tolerance(A) 公差	Watts 瓦
GP-TL2536-27	26~36VDC	250mA	78%	\pm 6%	9W
GP-TL3724-27	15~24VDC	370mA	75%	\pm 6%	9W
GP-TL7512-27	7~12VDC	750mA	72%	\pm 6%	9W

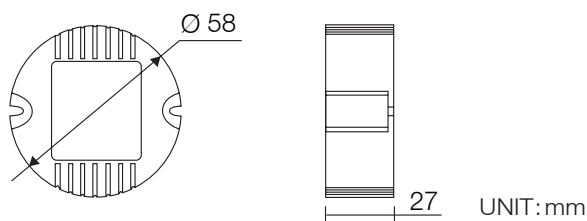

GP-TLxxxx-26 Series

Input Range from 120VAC \pm 10%.
 Work With Leading Edge and Trailing Edge Dimmers.
 With Power Factor Correction Function: PF > 0.9
 Designed for Indoor Application.
 Protections: Short-Circuit / Over Load.

Model No. 型号	Output Voltage 输出电压	Rated Current 额定电流	Efficiency 效率	Tolerance(A) 公差	Watts 瓦
GP-TL3536-26	24~36VDC	350mA	81%	\pm 6%	12W
GP-TL7018-26	12~18VDC	700mA	81%	\pm 6%	12W
GP-TLA012-26	7~12VDC	1000mA	78%	\pm 6%	12W

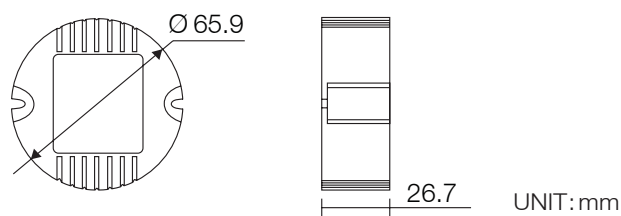



GP-TLxxx-15 Series

Input Range from 120VAC ± 10%.
 PFC to Reduce Power Consumption.
 Waterproof Packaging: IP65 for Dry and Wet Location.
 Protections: Short-Circuit / Over Load / Over Heat and Auto-Recovery Mode.
 Operates with Industry Standard Dimmers, Triac & Electronic Low Voltage Dimmers.

Model No. 型號	Output Voltage 輸出電壓	Rated Current 額定電流	Efficiency 效率	Tolerance(A) 公差	Watts 瓦
GP-TL3548-15	30~48VDC	350mA	79%	± 6%	16.8W
GP-TL5036-15	24~36VDC	470mA	82.5%	± 6%	16.8W
GP-TL7024-15	16~24VDC	700mA	81.5%	± 6%	16.8W
GP-TLA115-15	10~15VDC	1120mA	80%	± 6%	16.8W
GP-TLA212-15	8~12VDC	1250mA	79%	± 6%	15W

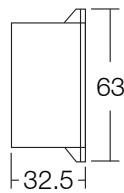
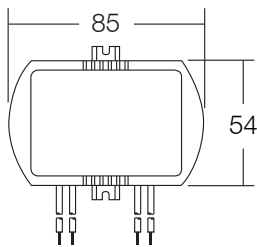

UNIT:mm



GP-TLxxx-15 (24W) Series



Input Range from 120VAC ± 10%.
 PFC to Reduce Power Consumption.
 Waterproof Packaging: IP65 for Dry and Wet Location.
 Protections: Short-Circuit / Over Load / Over Heat and Auto-Recovery Mode.
 Operates with Industry Standard Dimmers, Triac & Electronic Low Voltage Dimmers.

Model No. 型號	Output Voltage 輸出電壓	Rated Current 額定電流	Efficiency 效率	Tolerance(A) 公差	Watts 瓦
GP-TL5048-15	20~48VDC	500mA	79%	± 6%	24W
GP-TL7036-15	24~36VDC	700mA	82.5%	± 6%	24W
GP-TLA024-15	10~24VDC	1000mA	82%	± 6%	24W
GP-TLA220-15	10~20VDC	1200mA	79%	± 6%	24W

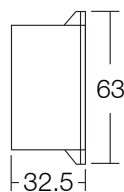
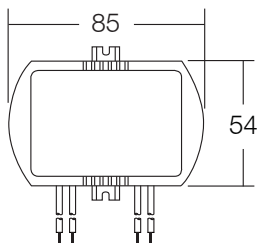

UNIT:mm



24 LED CC Driver - Plastic Housing **CC Triac Dimming**
 GP-TH Series (9W ~ 24W, 207Vac ~ 253Vac)



GP-THxxxx-27 Series

Input Range from 230VAC \pm 10%.
 Work With Leading Edge and Trailing Edge Dimmers.
 With Power Factor Correction function: PF > 0.9
 Designed for Indoor Application.
 Protections: Short-Circuit / Over Load.

Model No. 型號	Output Voltage 輸出電壓	Rated Current 額定電流	Efficiency 效率	Tolerance(A) 公差	Watts 瓦
GP-TH2536-27	18~36VDC	250mA	79%	\pm 6%	9W
GP-TH3724-27	18~24VDC	370mA	79%	\pm 6%	9W
GP-TH7512-27	7~12VDC	750mA	72%	\pm 6%	9W

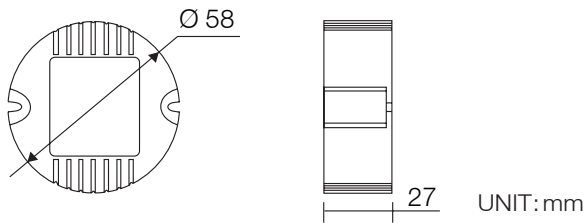

GP-THxxxx-26 Series

Input Range from 230VAC \pm 10%.
 Work With Leading Edge and Trailing Edge Dimmers.
 With Power Factor Correction function: PF > 0.9
 Designed for Indoor Application.
 Protections: Short-Circuit / Over Load.

Model No. 型號	Output Voltage 輸出電壓	Rated Current 額定電流	Efficiency 效率	Tolerance(A) 公差	Watts 瓦
GP-TH3536-26	24~36VDC	350mA	78%	\pm 6%	12W
GP-TH7018-26	12~18VDC	700mA	79%	\pm 6%	12W
GP-THA012-26	7~12VDC	1000mA	80%	\pm 6%	12W

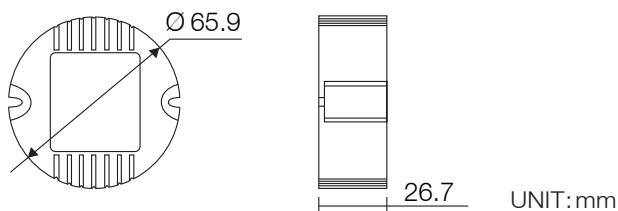

GP-THxxx-15 Series



Input Range from 230VAC \pm 10%.
 PFC to Reduce Power Consumption.
 Designed for Indoor Application.
 Waterproof Packaging: IP65 for Dry and Wet Location.
 Operates with Industry Standard Dimmers, Triac & Electronic Low Voltage Dimmers.
 Protections: Short-Circuit / Over Load / Over Heat and Auto-Recovery Mode.

Model No. 型號	Output Voltage 輸出電壓	Rated Current 額定電流	Efficiency 效率	Tolerance(A) 公差	Watts 瓦
GP-TH3548-15	30~48VDC	350mA	80%	\pm 6%	16.8W
GP-TH5036-15	24~36VDC	470mA	82.5%	\pm 6%	16.8W
GP-TH7024-15	16~24VDC	700mA	81%	\pm 6%	16.8W
GP-THA212-15	8~12VDC	1250mA	80%	\pm 6%	15W

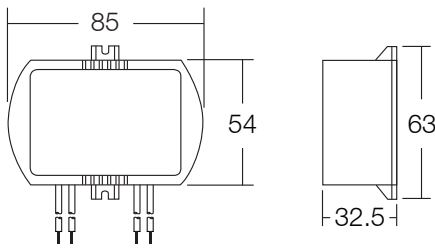

UNIT:mm



GP-THxxx-15 (24W) Series



Input Range from 230VAC \pm 10%.
 PFC to Reduce Power Consumption.
 Designed for Indoor Application.
 Waterproof Packaging: IP65 for Dry and Wet Location.
 Operates with Industry Standard Dimmers, Triac & Electronic Low Voltage Dimmers.
 Protections: Short-Circuit / Over Load / Over Heat and Auto-Recovery Mode.

Model No. 型號	Output Voltage 輸出電壓	Rated Current 額定電流	Efficiency 效率	Tolerance(A) 公差	Watts 瓦
GP-TH5048-15	28~48VDC	500mA	79%	\pm 6%	24W
GP-TH7036-15	24~36VDC	700mA	82.5%	\pm 6%	24W
GP-THA024-15	12~24VDC	1000mA	82%	\pm 6%	24W
GP-THA220-15	10~20VDC	1200mA	79%	\pm 6%	24W

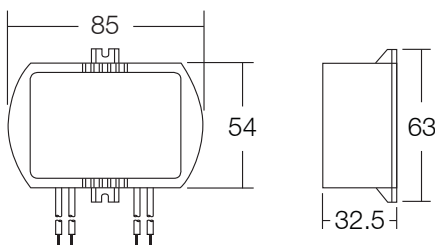

UNIT:mm



GP-HS15P-42C



Universal AC Input from 90~264VAC.
 Protection: SCP and OTP.
 Class II Power Design Without Earth Pin.
 Operating Temperature from -20°C~60°C at Full Load.
 Set Up Time is Less Than 0.5 Sec at Full Load.
 Compliant with ErP EU 1194/2012, Stage 3 Directives for Energy Related Products.
 DC Power Jack /Connector 2.1mm x 5.5mm Easy for Installation and Maintenance.

Model No. 型號	Output Voltage 輸出電壓	Rated Current 額定電流	Efficiency 效率	Tolerance(V) 公差	Watts 瓦
GP-HS15P-42C	26~42VDC	350mA	84%	± 5%	14.7W

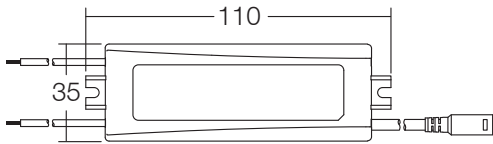

CE FC c UL US SELV IP67 □ ⊕ ⊗

UNIT:mm

GP-HS15P-42CA



Universal AC Input from 90~264VAC.
 3-in-1 Dimming Function: 0-10V, PWM, or Resistor.
 Protection: SCP / OTP.
 Class II Power Design Without Earth Pin.
 Operating Temperature from -20°C~60°C at Full Load.
 Set Up Time is Less Than 0.5 Sec at Full Load.
 Compliant with ErP EU 1194/2012, Stage 3 Directives for Energy Related Products.
 DC Power Jack / Connector 2.1mm x 5.5mm Easy for Installation and Maintenance.

Model No. 型號	Output Voltage 輸出電壓	Rated Current 額定電流	Efficiency 效率	Tolerance(V) 公差	Watts 瓦
GP-HS15P-42CA	26~42VDC	350mA	82%	± 5%	14.7W

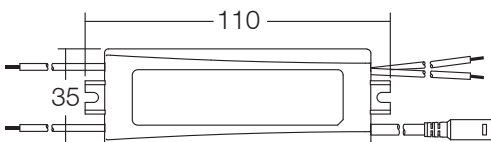

CE FC SELV IP67 □ ⊕ ⊗

UNIT:mm



GP-RS35P-42C (CV+CC)

Universal AC Input from 90~305VAC.
 Built-in Active PFC Function.
 Protections: OVP/ SCP/ OTP.
 Compliant with ErP EU 1194/2012, Stage 2 Directives for Energy Related Products.
 No Load Consumption is Less Than 1W.
 Set Up Time is Less Than 0.5 Sec at 230VAC.
 DC Power Jack /Connector 2.1mm x 5.5mm easy for Installation and Maintenance.

Model No. 型號	Output Voltage 輸出電壓	Rated Current 額定電流	Efficiency 效率	Tolerance(V) 公差	Watts 瓦
GP-RS35P-42C	33~42VDC	800mA	82%	± 5%	33.6W

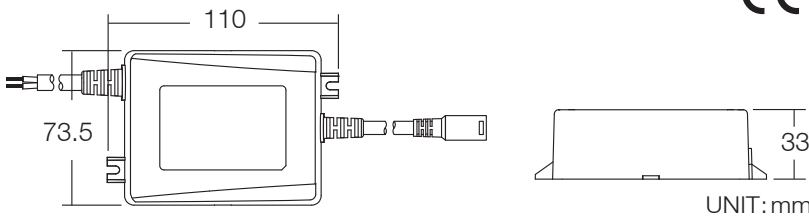

GP-RS35P-42CA (CV+CC)

Universal AC Input from 90~305VAC.
 Built-in Active PFC Function.
 Protections: OVP / SCP / OTP.
 3-in-1 Dimming Function (DC 0-10 V, PWM, and Resistor).
 Compliant with ErP EU 1194/2012, Stage 2 Directives for Energy Related Products.
 No Load Consumption is Less Than 1W.
 Set Up Time is Less Than 0.5 Sec at 230VAC.
 DC Power Jack / Connector 2.1mm x 5.5mm Easy for Installation and Maintenance.

Model No. 型號	Output Voltage 輸出電壓	Rated Current 額定電流	Efficiency 效率	Tolerance(V) 公差	Watts 瓦
GP-RS35P-42CA	33~42VDC	800mA	82%	± 5%	33.6W

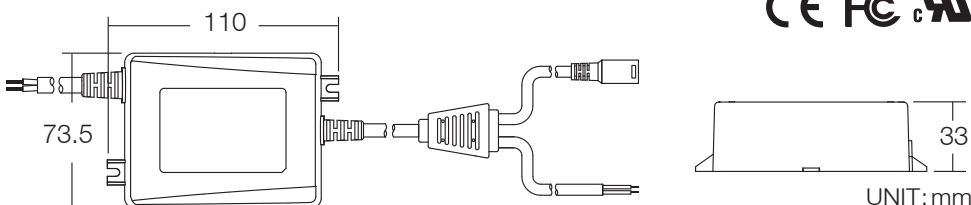

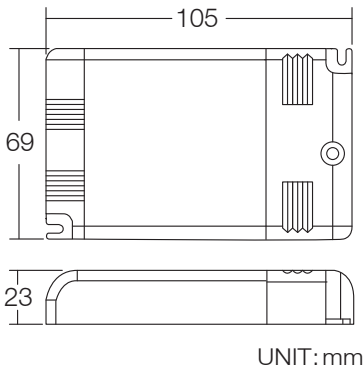

GP-LC7028-Q5D Series

Universal AC Input Range up to 264VAC.

Built-in Active PFC Function.

CC Mode with 1-10V Dimming and PUSH Dimming.

At CV Mode Operation, it Can Support Most of LED Strip Dimming Application.

Protections: Over Current Protection / Short Circuit Protection.

According to the switches selection							
Rated Power	SPEC	1	2	3	4	5	6
7W(C.C)	250mA	-	-	-	-	-	-
10W(C.C)	350mA	-	-	-	-	-	ON
12W(C.C)	400mA	-	-	-	-	ON	-
13W(C.C)	450mA	-	-	-	ON	-	-
14W(C.C)	500mA	-	-	-	-	ON	ON
15W(C.C)	550mA	-	-	-	ON	-	ON
17W(C.C)	600mA	-	-	-	ON	ON	-
20W(C.C)	700mA	-	-	-	ON	ON	ON
9W(C.V)	12VDC	-	-	ON	ON	ON	ON
18W(C.V)	24VDC	-	ON	-	ON	ON	ON
20W(C.V)	28VDC	ON	-	-	ON	ON	ON



GP-LS45P Series



Universal AC Input 90~305VAC.
 Built-in Active PFC Function.
 Protections: OVP / OCP / SCP / OTP.
 No Load Consumption <0.5W.
 Set up Time: < 0.5 Sec at 230VAC.
 Compliant with ErP EU_1194_2012,
 Stage 3 Directives for Energy Related Products.

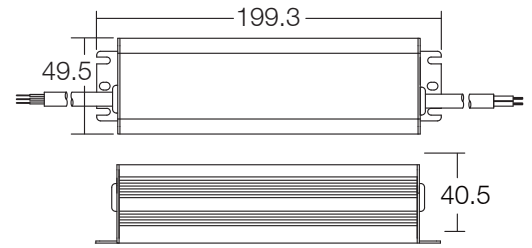

Model No. 型號	Output Voltage 輸出電壓	Rated Current 額定電流	Efficiency 效率	Tolerance(A) 公差	Watts 瓦
GP-LS45P-24C	16~24VDC	1.85A	85%	± 5%	44.4W
GP-LS45P-36C	24~36VDC	1.25A	86%	± 5%	45W
GP-LS45P-42C	33~42VDC	1.05A	86%	± 5%	44.1W
GP-LS45P-48C	33~48VDC	1A	87%	± 5%	48W
GP-LS45P-57C	40~57VDC	0.7A	87%	± 5%	40W



GP-LS60P Series



Universal AC Input 90~305VAC.
 Built-in Active PFC Function.
 Protections: OVP / OCP / SCP / OTP.
 No Load Consumption <0.5W.
 Set up Time: < 0.5 Sec at 230VAC.
 Compliant with ErP EU_1194_2012,
 Stage 3 Directives for Energy Related Products.

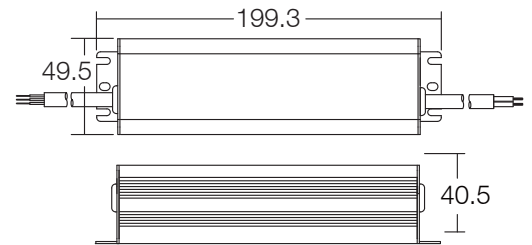

Model No. 型號	Output Voltage 輸出電壓	Rated Current 額定電流	Efficiency 效率	Tolerance(A) 公差	Watts 瓦
GP-LS60P-12C	9~12VDC	4.2A	86%	± 5%	50.4W
GP-LS60P-24C	16~24VDC	2.5A	86%	± 5%	60W
GP-LS60P-36C	24~36VDC	1.65A	87%	± 5%	59.4W
GP-LS60P-42C	33~42VDC	1.4A	87%	± 5%	58.8W
GP-LS60P-48C	33~48VDC	1.2A	88%	± 5%	57.6W
GP-LS60P-57C	40~57VDC	1.05A	88%	± 5%	59.8W



30 LED CC Driver - Metal Housing (PFC, IP67) **CC-IP**
GP-LS Series (40W ~ 200W)



GP-LS050P Series (CV+CC)

Universal AC Input 100~277VAC.
 Built-in PFC Function.
 Protections: OCP / SCP / OTP.
 Cooling by Free Air Convection.

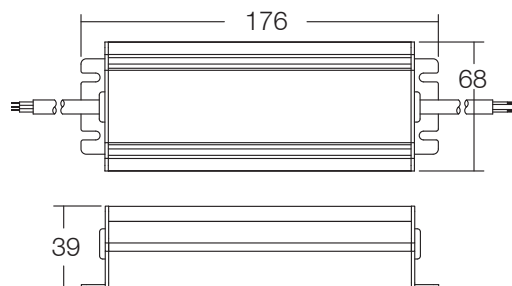

Model No. 型號	Output Voltage 輸出電壓	Rated Current 額定電流	Efficiency 效率	Tolerance(A) 公差	Watts 瓦
GP-LS050P-12	8~12VDC	4.2A	82%	± 5%	50W
GP-LS050P-24	18~24VDC	2.1A	85%	± 5%	50W
GP-LS050P-36	25~36VDC	1.4A	87%	± 5%	50W
GP-LS050P-48	33~48VDC	1.05A	87%	± 5%	50W



GP-LS070P Series (CV+CC)

Universal AC Input 100~277VAC.
 Built-in PFC Function.
 Protections: OCP / SCP / OTP.
 Cooling by Free Air Convection.

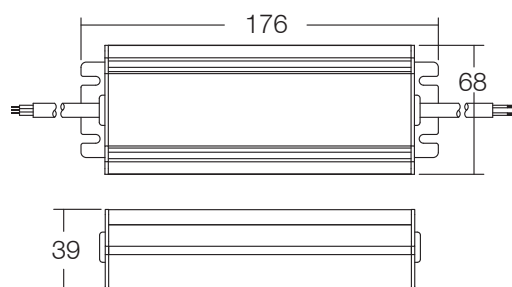

Model No. 型號	Output Voltage 輸出電壓	Rated Current 額定電流	Efficiency 效率	Tolerance(A) 公差	Watts 瓦
GP-LS070P-12	10~12VDC	4.9A	86%	± 5%	59W
GP-LS070P-24	18~24VDC	3.2A	86%	± 5%	75W
GP-LS070P-30	20~30VDC	2.4A	86%	± 5%	73.5W
GP-LS070P-36	25~36VDC	2.1A	86%	± 5%	75.6W
GP-LS070P-48	33~48VDC	1.4A	86%	± 5%	67W
GP-LS070P-54	37~54VDC	1.4A	86%	± 5%	75W





GP-LS100P Series (CV+CC)

Universal AC Input 90~305VAC.
 Built-in PFC Function.
 Protections: OVP / OCP / SCP / OTP.
 Cooling by Free Air Convection.

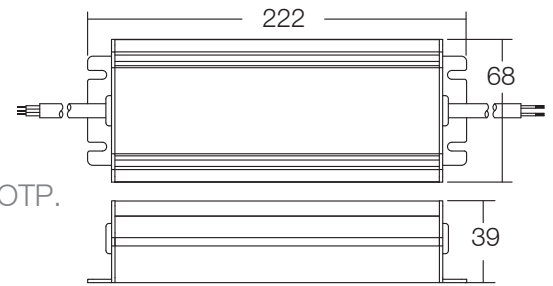

Model No. 型號	Output Voltage 輸出電壓	Rated Current 額定電流	Efficiency 效率	Tolerance(A) 公差	Watts 瓦
GP-LS100P-12	9~12VDC	8.3A	88%	± 5%	99.6W
GP-LS100P-15	10~15VDC	6.6A	88%	± 5%	99W
GP-LS100P-24	14~24VDC	4.2A	90%	± 5%	100.8W
GP-LS100P-30	22~30VDC	3.3A	90%	± 5%	99W
GP-LS100P-36	26~36VDC	2.8A	90%	± 5%	100.8W
GP-LS100P-48	34~48VDC	2.1A	90.5%	± 5%	100.8W
GP-LS100P-57	43~57VDC	1.75A	90.5%	± 5%	99.7W



GP-LS150P Series (CV+CC)

Universal AC Input 90~305VAC.
 Built-in PFC Function.
 Protections: OVP / OCP / SCP / OTP.
 Cooling by Free Air Convection.

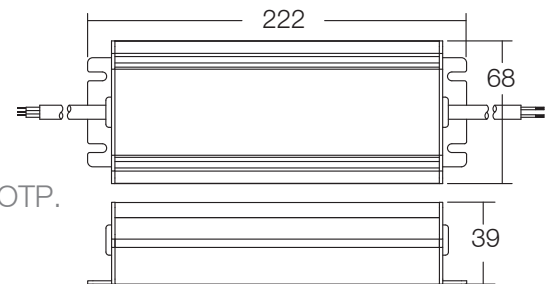

Model No. 型號	Output Voltage 輸出電壓	Rated Current 額定電流	Efficiency 效率	Tolerance(A) 公差	Watts 瓦
GP-LS150P-12	9~12VDC	11A	88%	± 5%	132W
GP-LS150P-15	10~15VDC	10A	88%	± 5%	150W
GP-LS150P-24	14~24VDC	6.3A	90%	± 5%	151.2W
GP-LS150P-30	22~30VDC	5A	90%	± 5%	150W
GP-LS150P-36	26~36VDC	4.2A	90%	± 5%	151.2W
GP-LS150P-48	34~48VDC	3.2A	90%	± 5%	153.6W
GP-LS150P-54	38~54VDC	2.8A	90%	± 5%	151.2W



32 LED CC Driver - Metal Housing (PFC, IP67) **CC - IP**

GP-LS Series (40W ~ 200W)



GP-LS200P Series (CV+CC)

Universal AC Input 100~277VAC.
Withstand 277VAC Input.
Built-in PFC Function.
Protections: OVP / OCP / SCP / OTP.
Cooling by Free Air Convection.

Model No. 型號	Output Voltage 輸出電壓	Rated Current 額定電流	Efficiency 效率	Tolerance(A) 公差	Watts 瓦
GP-LS200P-12	9~12VDC	13.4A	87%	± 5%	160.8W
GP-LS200P-24	16~24VDC	8.3A	90%	± 5%	199.2W
GP-LS200P-36	27~36VDC	5.6A	90%	± 5%	201.6W
GP-LS200P-48	37~48VDC	4.1A	90%	± 5%	196.8W

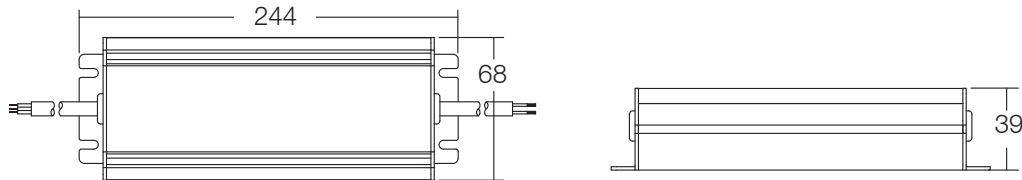

LED CC Driver - Metal Housing (PFC) **CC - Terminal Blocks**

GP-LC Series (48W)



GP-LCxxxx-32D 48W Series

Universal Input Range from 100V-277V.
Built-in PFC Function.
Protections: Short-Circuit.
Dimming Controlled at Secondary Side.
Standard Dimmer 0-10V Electronic Potentiometer.
(Part No. GL-EC013)
Wire up to 10pcs Dimmable Dimmers.
(GL-EC013 Charged Addtionally)

Model No. 型號	Output Voltage 輸出電壓	Rated Current 額定電流	Efficiency 效率	Tolerance(A) 公差	Watts 瓦
GP-LCD012-32D	8~12VDC	4000mA	>80%	± 6%	48W
GP-LCB024-32D	14~24VDC	2000mA	>84%	± 6%	48W
GP-LCA336-32D	24~36VDC	1330mA	>85%	± 6%	48W
GP-LCA048-32D	36~48VDC	1000mA	>85%	± 5%	48W
GP-LC6672-32D	48~72VDC	665mA	>85%	± 6%	48W

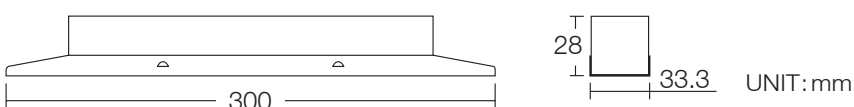

GP-LS45P-xxCA Series



Universal AC Input 90~305VAC.
Built-in Active PFC Function.
No Load Consumption < 0.5W.
Set Up Time: < 0.5 Sec at 230VAC.
Protections: OVP / OCP / SCP / OTP.
3-in-1 Dimming Function.
Compliant with ErP EU_1194_2012,
Stage 3 Directives for Energy Related Products.

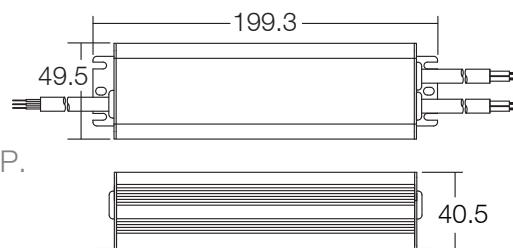

Model No. 型號	Output Voltage 輸出電壓	Rated Current 額定電流	Efficiency 效率	Tolerance(A) 公差	Watts 瓦
GP-LS45P-24CA	16~24VDC	1.85A	85%	± 5%	44.4W
GP-LS45P-36CA	24~36VDC	1.25A	86%	± 5%	45W
GP-LS45P-42CA	33~42VDC	1.05A	86%	± 5%	44.1W
GP-LS45P-48CA	33~48VDC	1A	87%	± 5%	48W
GP-LS45P-57CA	40~57VDC	0.7A	87%	± 5%	40W



GP-LS60P-xxCA Series



Universal AC Input 90~305VAC.
Built-in Active PFC Function.
No Load Consumption < 0.5W.
Set Up Time: < 0.5 Sec at 230VAC.
Protections: OVP / OCP / SCP / OTP.
3-in-1 Dimming Function.
Compliant with ErP EU_1194_2012,
Stage 3 Directives for Energy Related Products.

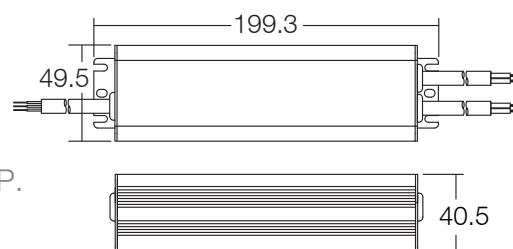

Model No. 型號	Output Voltage 輸出電壓	Rated Current 額定電流	Efficiency 效率	Tolerance(A) 公差	Watts 瓦
GP-LS60P-12CA	9~12VDC	4.2A	86%	± 5%	50.4W
GP-LS60P-24CA	16~24VDC	2.5A	86%	± 5%	60W
GP-LS60P-36CA	24~36VDC	1.65A	87%	± 5%	59.4W
GP-LS60P-42CA	33~42VDC	1.4A	87%	± 5%	58.8W
GP-LS60P-48CA	33~48VDC	1.2A	88%	± 5%	57.6W
GP-LS60P-57CA	40~57VDC	1.05A	88%	± 5%	59.8W



34 LED CC Driver - Metal Housing (PFC, IP67) **CC - High Voltage Output**
 GP-LS Series (70W ~ 150W)



GP-LS70PH / GP-LS100PH Series

Universal AC Input 90~305VAC.
 High Efficiency up to 91%.
 High Output Voltage.
 Built-in PFC Function.
 Protection: OVP / SCP / OTP.
 Cooling by Free Air Convection.

Model No. 型號	Output Voltage 輸出電壓	Rated Current 額定電流	Efficiency 效率	Tolerance(A) 公差	Watts 瓦
GP-LS70PH-100C	50~100VDC	700mA	90%	± 5%	70W
GP-LS100PH-71C	50~71VDC	1400mA	91%	± 5%	99.4W
GP-LS100PH-142C	100~142VDC	700mA	91%	± 5%	99.4W

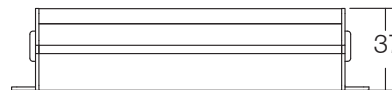
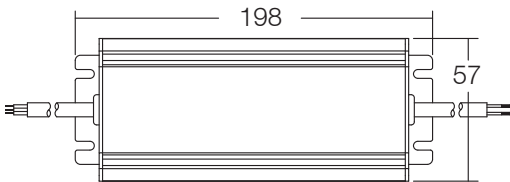

CE FC c UL us CB IP67 F 110

UNIT:mm

GP-LS Series (70W ~ 150W)



GP-LS150PH Series

Universal AC Input 90~305VAC.
 High Efficiency up to 92%.
 High Output Voltage.
 Built-in PFC Function.
 Protection: OVP / SCP / OTP.

Model No. 型號	Output Voltage 輸出電壓	Rated Current 額定電流	Efficiency 效率	Tolerance(A) 公差	Watts 瓦
GP-LS150PH-107C	30~107VDC	1400mA	91%	± 5%	149.8W
GP-LS150PH-143C	60~143VDC	1050mA	92%	± 5%	150.1W
GP-LS150PH-210C	60~210VDC	700mA	92%	± 5%	147W
GP-LS150PH-428C	120~428VDC	350mA	92%	± 5%	149.8W

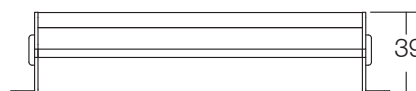
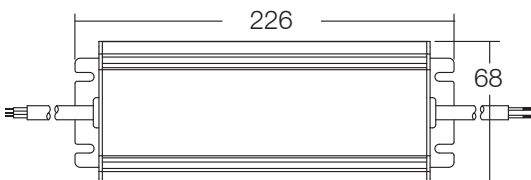

CE FC c UL us CB IP67 110 F M M

UNIT:mm



GP-LS150PH Dimming Series

Universal AC Input 90 ~ 305VAC.
 High Efficiency up to 92%.
 High Output Voltage.
 Built-in PFC Function.
 Protection: OVP / SCP / OTP.

Model No. 型號	Output Voltage 輸出電壓	Rated Current 額定電流	Efficiency 效率	Tolerance(A) 公差	Watts 瓦
GP-LS150PH-107CA	75~107VDC	1400mA	91%	± 5%	149.8W
GP-LS150PH-143CA	90~143VDC	1050mA	92%	± 5%	150.1W
GP-LS150PH-210CA	120~210VDC	700mA	92%	± 5%	147W
GP-LS150PH-428CA	250~428VDC	350mA	92%	± 5%	149.8W

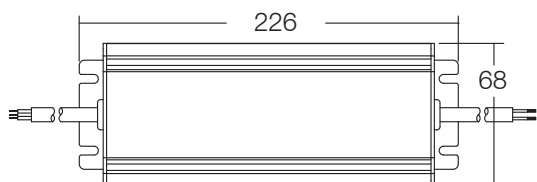

CE FC cULus IP67 ∇_{110} ∇_F ∇_M ∇_M ∇_{circle}

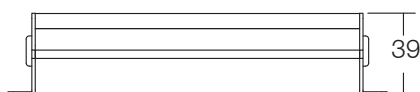

UNIT:mm

36 LED CC Driver - Metal Housing (PFC, IP67) **CC - IP68 Cable Connector**
 GP-LS Series (60W ~ 200W)



GP-LS60P-42C 1E

Universal AC Input, from 90 up to 305VAC.

IP67 Rated Enclosure, Provides Protection from Water and Dust.

Waterproof IP68 Rated Connectors, for Convenient Maintenance.

OCP, OVP, OTP, and SCP Safety Features are Built in.

Consumes Less Than 0.5W in No Load Conditions.

Model No. 型號	Output Voltage 輸出電壓	Rated Current 額定電流	Efficiency 效率	Tolerance(A) 公差	Watts 瓦
GP-LS60P-42C 1E	28-42V	1.4A	87%	± 5%	58.8W

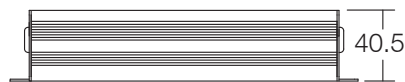
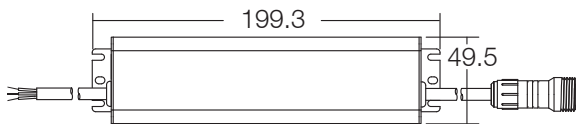

GP-LS100P-xx 1E

Universal AC Input, from 90 to 305VAC.

Safety protections include OVP, OCP, SCP, and OTP.

IP67 Rated for Protection from Water and Dust.

IP68 Waterproof Connectors for Convenient Maintenance.

Compliant with the ErP (EU) No. 1194/2012,

Stage 3 Directives.

Consumes Less than 0.5W in Idle, No Load Status.

Model No. 型號	Output Voltage 輸出電壓	Rated Current 額定電流	Efficiency 效率	Tolerance(A) 公差	Watts 瓦
GP-LS100P-36 1E	30-40V	2.5A	90%	± 5%	100W
GP-LS100P-57 1E	48-60V	1.65A	90%	± 5%	100W



(only 36-1E)

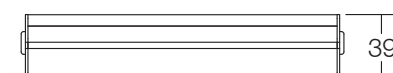
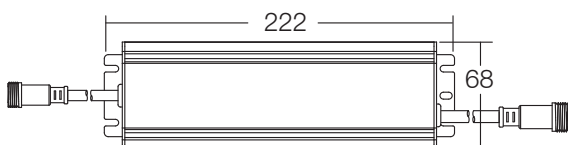



GP-LS150P-60

Universal AC Input, from 90 to 264VAC.
 Safety Protections Include OVP, OCP, SCP, and OTP.
 IP67 Rated for Protection from Water and Dust.
 IP68 Waterproof Connectors for Convenient Maintenance.

Model No. 型號	Output Voltage 輸出電壓	Rated Current 額定電流	Efficiency 效率	Tolerance(A) 公差	Watts 瓦
GP-LS150P-60	48-60V	2.5A	90%	± 5%	150W

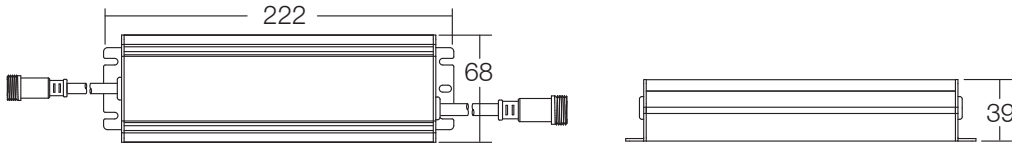

GP-LS200P-60 1E

Universal AC Input, from 90 to 295VAC.
 Safety Protections Include OVP, OCP, SCP, and OTP.
 IP67 Rated Enclosure, for Protection from Water and Dust.
 IP68 Waterproof Connectors, for Convenient Maintenance.

Model No. 型號	Output Voltage 輸出電壓	Rated Current 額定電流	Efficiency 效率	Tolerance(A) 公差	Watts 瓦
GP-LS200P-60 1E	48-60V	3.2A	90%	± 5%	192W

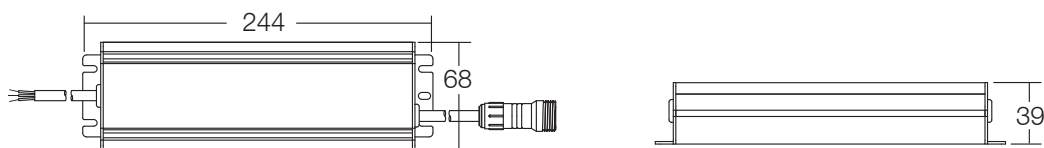



website



facebook

GlacialTech®

洋鑫科技股份有限公司 **GlacialTech Inc.**

地址：新北市中和區235中山路二段352號7樓
7F, No. 352, Sec. 2, Zhongshan Rd., Zhonghe Dist.,
New Taipei City, Taiwan, 235

Tel : +886 2 2244-1227 Fax : +886 2 2244-1228

Email : sales@GlacialTech.com Website : www.GlacialTech.com

